

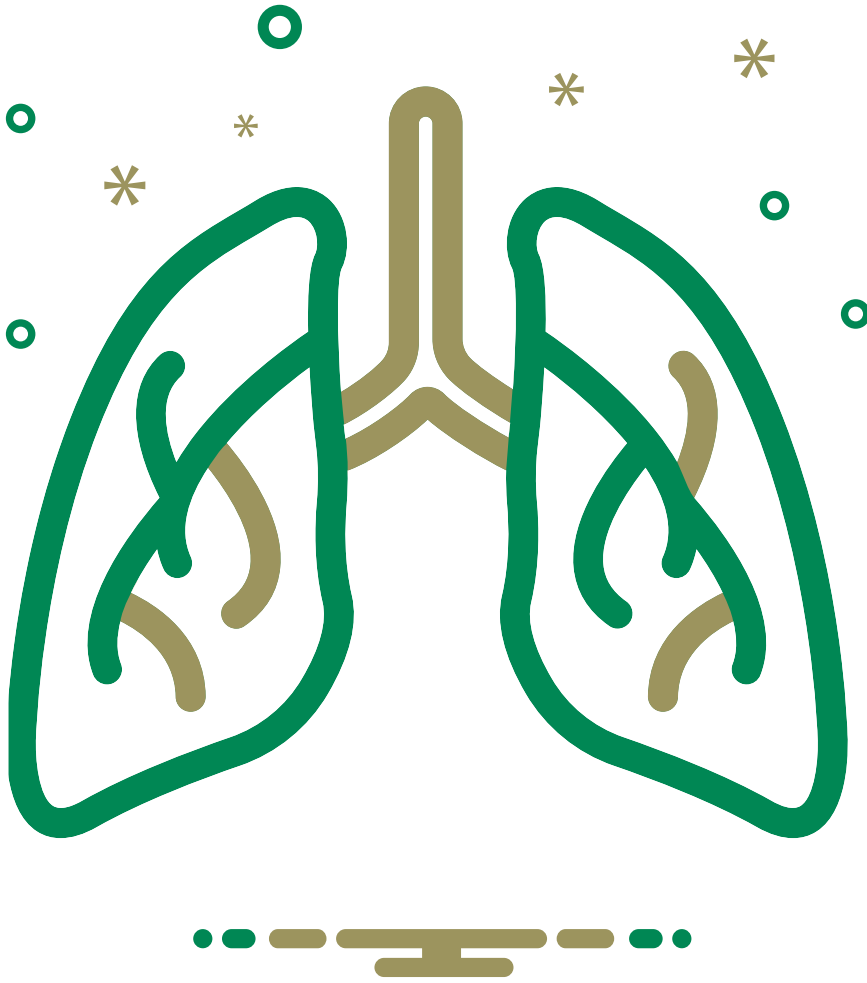

وزارة الصحة
Ministry of Health

KINGDOM OF SAUDI ARABIA



National Tuberculosis Program

Manual 2021

National Tuberculosis Program Manual

Current Authors & Reviewers

Hani Jokhdar

Consultant of Public Health and
Infectious Disease Epidemiology
Deputy Minister for Public Health

Abdullah M Assiri

Consultant of Infectious Diseases
Assistant Deputy Minister for
Preventive Health

Ahmed Mohamed Hakawi

Consultant of Infectious Diseases
Director-General, the General Directorate of
Infectious Disease Control, MOH

Maha Al-Alawi

Consultant Infection Prevention and
Control
National TB Program Manager
King Abdulaziz University, Jeddah

Naif Alotaibi

Consultant of Infectious Diseases
King Saud University Medical City

Abdulrahman Alodayani

Head of Pediatric Infectious Disease
Prince Sultan Military Medical City

Reem S. Almaghrabi

Transplant Infectious Diseases
Department of Medicine
King Faisal Specialist Hospital and
Research Centre, Riyadh

Mohammed O. Qutub

Senior Clinical Scientist
Consultant Clinical Microbiology
King Faisal Specialist Hospital &
Research Centre

Samira Aljohani

Professor of Medical
Microbiology at National Guard
hospital

Oweida F. Aldosary

Consultant adult HIV / Infectious
Diseases
King Fahad Medical City

Mrs Abeer Albalawi

Senior Epidemiologist
National Tuberculosis Program

Majid Alshamrani

Executive Director Infection Prevention
and Control Program
Ministry of National Guard-Health Affairs

Sara Ahmed Eltigani

Consultant Medical Microbiology
National Tuberculosis Program

Mrs. Hawa Fallatah

Administrative Specialist

Ahmed Osman Ali

Public Health Physician
National Tuberculosis Program



A special acknowledgement with much appreciation, to Ms. Janet Count, and her team from, the World Health Organization for reviewing the manual

CONTENTS

Current Authors & Reviewers	i
Abbreviations and Acronyms.....	xiii
1. Introduction	1
1.1. Microbiological preamble	1
1.2. Transmission and Infection	1
1.3. Epidemiology of TB	2
1.3.1. Global situation	2
1.3.2. Situation in the Kingdom of Saudi Arabia.....	2
References.....	3
2. National Tuberculosis Program (NTP) in the Kingdom of Saudi Arabia	5
2.1. Background.....	5
2.2. Elements of the National Tuberculosis Program (NTP)	6
2.3. Major policies of the NTP	6
2.4. Organizational Structure	9
2.5. NTP central unit and regional TB program.....	9
2.6. Guidelines for National Tuberculosis Program.....	9
2.7. Case based electronic TB surveillance system.....	10
2.8. Training	10
2.9. Laboratory services.....	10
2.10. X-ray services.....	10
2.11. Treatment services	10
2.12. Medical supply and other similar service provider.....	10
2.13. Structure of NTP and job description.....	11
2.13.1. The ministerial level of NTP (Central level).....	11
2.13.2. Intermediate level (Regional coordinator/District level).....	12
2.13.3. Peripheral level (Implementing units).....	13
2.14. Supporting services	15
2.14.1. Laboratories	15
2.14.2. X-ray services	17
2.14.3. Drug supply policy:.....	17
3. Diagnosis of Tuberculosis.....	18

3.1. Algorithm 1: Universal patient access to rapid testing regarding MTB detection and rifampicin resistance evaluation	18
3.1.1. Scope and specifications	18
3.1.2. Operational procedures for Algorithm 1	22
3.2. Algorithm 2: Limited patient access to rapid testing regarding MTB detection and rifampicin resistance evaluation – Interim decision tress based on rapid testing for priority populations.....	26
3.2.1. Scope and specifications	26
3.2.2. Operational procedures for Algorithm 2	28
3.3. Algorithm 3: Testing for second-line drug resistance among rifampicin-resistant TB or MDR-TB patients	30
3.3.1. Scope and specifications	30
3.3.2. Operational procedures for Algorithm 3	32
3.4. Algorithm 4: Evaluation of TB among PLHIV who are seriously ill or have CD4 accounts≤100 cells/μl.....	35
3.4.1. Scope and specifications.....	35
3.4.2.Operational procedures for Algorithm 4.....	38
Reference	39
4. Tuberculosis Laboratory Diagnostic Methods	40
4.1. Biosafety in Laboratory diagnosis of tuberculosis	40
4.1.1. Biohazard Warning Sign for laboratory doors	40
4.1.2. General safety rules.....	41
4.2. Quality assurance and quality control	42
4.3. Smear microscopy	42
4.3.1. Sample collection.....	43
4.3.2. Criteria of acceptability.....	43
4.3.3. Microscope Components	43
4.3.4. Reporting of Microscopy Smears.....	44
4.3.5. Common Causes of Error in Smear Microscopy.....	44
4.4. Culture tests for <i>Mycobacterium tuberculosis</i> complex.....	44
4.4.1. Liquid media.....	46
4.5. Line probe assay for MTB and MDR- and XRD-TB identification	47
4.6. First- and second-line drug susceptibility testing for <i>Mycobacterium tuberculosis</i> complex	48

4.6.1.	General method – DST by culture	48
4.6.2.	Automated real-time DNA amplification test for rapid and simultaneous detection of TB and rifampicin resistance XPERT® MTB/RIF ASSAY	49
4.6.3.	Ultra ‘MTB detected trace’, culture negative	50
	Reference	51
5.	Treatment of Tuberculosis	52
5.1.	Background	52
5.2.	Aims of treatment	52
5.3.	Hospitalization	52
5.4.	Health education	52
5.5.	General procedures that should be followed during treatment	52
5.5.1.	Drug-susceptible pulmonary TB	52
5.5.2.	PLHIV, ART & TB treatment	53
5.5.3.	Extrapulmonary TB	53
5.5.4.	Health education & adherence	53
5.6.	Factors to be considered in deciding to initiate empirical treatment	54
5.7.	Summary of changes in the new guidelines 2017 and policy recommendations on treatment of drug-susceptible TB	54
5.8.	Treatment of TB in specific situations	56
5.8.1.	Treatment of pregnant and breast-feeding woman	56
5.8.2.	Contraceptive pills and anti-TB drugs	57
5.8.3.	Treatment of patients with liver disorders	57
5.8.4.	Treatment of patients with renal failure	58
5.9.	Essential first-line drugs in treatment of tuberculosis	58
5.9.1.	Isoniazid	58
5.9.2.	Rifampicin	59
5.9.3.	Pyrazinamide	60
5.9.4.	Ethambutol	60
5.10.	Symptom-based approach to managing anti-TB drugs side effects	62
5.11.	Moderate/severe hypersensitivity (immune) drug reactions	62
5.11.1.	Management of moderate/severe hypersensitivity reactions	62
5.11.2.	Re-challenge guidelines	63

5.11.3.	Drug desensitization	63
5.12.	Drug interaction	64
	Reference	64
6.	Monitoring response to treatment	65
6.1.	Background	65
6.2.	Assessing treatment response in newly diagnosed or previously treated pulmonary tuberculosis patients	65
6.3.	Assessing treatment response in extrapulmonary TB patients	66
6.4.	Recording the standardized treatment outcome	66
6.5.	Cohort analysis of treatment outcomes.....	66
6.6.	Management of treatment interruption	67
6.7.	Treatment in specific situations	67
6.7.1.	Pregnant women and children of smear-positive pulmonary TB mothers:	67
6.7.2.	Patients with liver disorders	67
6.7.3.	Patients with renal failure.....	68
6.7.4.	Management of adverse sensitivity drug reactions.....	68
7.	Tuberculosis in Children	69
7.1.	Background.....	69
7.2.	Key features suggestive of TB in children.....	69
7.3.	Recommended approach to diagnose TB in children	69
7.3.1.	Careful history taking	69
7.3.2.	Symptoms.....	70
7.3.3.	Clinical examination (including growth assessment)	70
7.3.4.	Tuberculin skin test (TST).....	70
7.3.5.	Bacteriological confirmation whenever possible	71
7.3.6.	Investigations relevant to suspected pulmonary and extrapulmonary TB in children	71
7.4.	Treatment of TB in children	72
7.5.	Ensuring adherence	73
7.6.	Follow-up.....	74
7.7.	Adverse events	74
8.	Tuberculosis & HIV.....	76
8.1.	Background.....	76

8.2.	Interaction between tuberculosis and HIV.....	76
8.2.1.	The effects of HIV infection on TB epidemiology, morbidity and management.....	76
8.2.2.	The effects of TB on HIV.....	76
8.3.	Objectives of the NTP regarding PLHIV.....	77
8.4.	Diagnosis of tuberculosis among HIV positive individuals.....	78
8.5.	Collaborative activities between NTP and AIDS Program.....	81
8.5.1.	To decrease the TB burden in people living with HIV/AIDS.....	81
8.5.2.	To decrease the burden of HIV in TB patients:.....	81
8.5.3.	Treatment of tuberculosis among HIV positive individuals.....	82
8.5.4.	Cotrimoxazole preventive therapy.....	82
8.5.5.	Prevention of HIV transmission at health care facilities.....	82
8.5.6.	Antiretroviral therapy (ART).....	82
	Reference.....	83
9.	Recording and Reporting System.....	84
9.1.	Background.....	84
9.2.	Definitions used by NTP.....	86
9.2.1.	Case definitions.....	86
9.2.2.	Treatment susceptibility definitions.....	88
9.2.3.	Outcome definitions.....	88
9.2.4.	Outcomes for RR-TB/MDR-TB/XDR-TB patients treated using second-line treatment.....	89
9.3.	Codes used by NTP in recording and reporting TB patients.....	90
9.4.	Code letters for directorates of health affairs in the Kingdom.....	90
9.5.	General rules for recording and reporting TB cases:.....	91
9.6.	Registers and forms used by the NTP.....	92
9.6.1.	Registers.....	92
9.6.2.	Forms.....	93
9.7.	Treatment box.....	95
	Reference.....	96
10.	Drug Resistant TB.....	97
10.1.	Definitions.....	97
10.2.	Epidemiology.....	97
10.3.	Risk factors.....	98

10.4.	Diagnosis.....	98
10.5.	Treatment	99
10.5.1.	Regimens for isoniazid-resistant tuberculosis (Hr-TB).....	99
10.5.2.	Composition of longer MDR-TB regimens	99
10.6.	Important considerations	101
10.7.	Strategy	102
10.8.	Investigations to be done at baseline	104
10.9.	Investigations to be monitored.....	104
	Reference	109
11.	BCG Vaccination	110
11.1.	Background	110
11.2.	BCG vaccine indicators	110
11.3.	Vaccination of older groups and special populations, contraindications & precautions.....	111
11.4.	Storage and validity.....	111
11.5.	Reconstitution of BCG Vaccine SSI (10-dose vial).....	112
11.6.	Dosage	112
11.7.	Injection site.....	112
11.8.	Dosage of BCG vaccine	112
11.9.	Injection technique.....	113
11.10.	After injection.....	113
11.11.	Adverse effects.....	113
11.11.1.	Mild adverse effects	113
11.11.2.	Severe adverse effects.....	114
11.12.	BCG vaccination and other vaccines.....	115
11.13.	Management of BCG vaccination adverse effects	115
12.	Latent Tuberculosis	116
12.1.	Definitions.....	116
12.2.	Identification and treatment of populations at risk for LTBI.....	117
12.3.	Algorithms to rule out active TB disease	118
12.4.	Testing for LTBI.....	119
12.5.	Treatment options for LTBI	120
12.6.	Preventive treatment for contacts of patients with MDR-TB.....	121

12.6.1.	General considerations	121
12.6.2.	Selection of drug regimen	122
12.6.3.	Resources and feasibility	122
12.6.4.	Close monitoring and treatment adherence.....	122
12.7.	Considerations for implementation	122
12.7.1.	Ethical consideration.....	122
12.7.2.	Adverse events monitoring	123
12.7.3.	Adherence and completion of preventive treatment	124
12.7.4.	Drug resistance and surveillance.....	124
12.7.5.	Interactions with antiretroviral drugs	124
12.8.	Program management, monitoring and evaluation.....	125
	Reference	127
13.	Tuberculin Testing.....	128
13.1.	Background	128
13.2.	Storage precautions for PDD antigen.....	128
13.3.	Test standardization.....	128
13.4.	Indications	129
13.4.1.	Individual with increased risk for new infection: (all patients should be tested regardless of age).....	129
13.4.2.	Individuals with clinical conditions associated with increased risk of TB reactivation.....	129
13.5.	Patient interview	129
13.6.	Administration (Mantoux test).....	130
13.6.1.	Administration precautions for PPD antigen	130
13.6.2.	Dose and administration	130
13.7.	Reading tuberculin test results (Mantoux test):.....	131
13.8.	Interpretation of the Mantoux TST Results.....	131
13.8.1.	Positivity criteria	132
13.8.2.	Causes of false negative results	132
13.8.3.	Causes of false positive	133
13.9.	Two-step testing	133
13.9.1.	Indications.....	133
13.9.2.	Procedure	134

13.10.	Referral.....	134
14.	Contact Screening.....	135
14.1.	Definitions.....	135
14.2.	Recommendations.....	136
14.3.	Timing for interviews and identification of Contacts	136
14.4.	Instigation of a Contact investigation.....	137
14.5.	Factors that increase likelihood of TB transmission	137
14.5.1.	Sputum Bacteriology.....	137
14.5.2.	Radiographic Findings	137
14.5.3.	Behaviors that increase aerosolization of respiratory secretions.....	137
14.5.4.	Administration of effective treatment.....	137
14.6.	Procedures for Contact investigation.....	138
14.6.1.	Collect Data related to the index case	138
14.6.2.	Assess the index case and decide whether to initiate contact investigation.....	138
14.6.3.	Determining the infectious Period	138
14.6.4.	Make an interview with the index case to obtain the following data:	138
14.6.5.	Field visit.....	138
14.6.6.	List the contacts with the required data in the contact register adopted by NTP.....	139
14.6.7.	Refer contacts to be investigated for TB.....	139
14.6.8.	Investigate contacts	139
14.6.9.	Monitoring and evaluation.....	139
	Reference	140
15.	Preventive Measures of Tuberculosis	141
15.1.	Background	141
15.2.	TB Infection-Control Measures.....	141
15.2.1.	Administrative controls.....	141
15.2.2.	Environmental measures	142
15.2.3.	Use of personal protective equipment	142
15.3.	Determining the Infectiousness of TB Patients.....	143
15.4.	NTP recommendations for protection against exposure to TB.....	143
16.	Health Education.....	144

16.1.	Background	144
16.2.	Framework.....	144
16.3.	Instruction for tuberculosis patients.....	144
17.	Patient Centered Approach to TB Care.....	147
17.1.	Introduction.....	147
17.2.	The objectives of Patient-centered approach to TB care	147
17.3.	Principles of Patient-centered approach to TB care	147
17.4.	What is DOT?.....	148
17.5.	Patient-centered care, social support and adherence to drug resistant TB treatment	149
17.6.	The supervision of Patient-centered approach to TB care at the district level	149
17.7.	Home DOTS team responsibilities	150
17.8.	Responsibilities of home DOTS mobile team personnel	151
17.8.1.	The doctor.....	151
17.8.2.	The nurse.....	152
17.8.3.	Health inspector.....	152
17.8.4.	Driver	152
17.9.	Role of home DOTS mobile team in health education for patients and contacts	152
17.9.1.	For all patients	152
17.9.2.	In TB/HIV patients.....	153
17.9.3.	cases among children	153
17.9.4.	Home DOTS mobile teams for TB patients in prisons	154
17.10.	Monitoring and follow up of the patient-centered approach to TB care mobile teams’ activities.....	155
	References.....	156
	NTP Guideline Appendices.....	157
	Appendix I-International Standard for TB Care	158
	Standards for Diagnosis.....	158
	Standards for Treatment.....	158
	Standards for Addressing HIV Infection and other Co-morbid Conditions.....	159
	Standards for Public Health	160
	Appendix II-Technical TB Program Indicators.....	161



Detection indicators	161
Enrolment indicators.....	162
Final Outcome indicators	162
Indicators for Drug-Resistant TB	163
Detection indicators.....	163
Enrolment indicators.....	164
Interim results indicators	165
Final outcome indicators	166
Appendix III-Forms and Registers used by National Tuberculosis Program	167

Abbreviations and Acronyms

AIDS	Acquired Immunodeficiency Syndrome
ART	Antiretroviral Therapy
CSF	cerebrospinal fluid
DOT	Directly Observation Therapy
DR-TB	Drug Resistant Tuberculosis
DST	Drug Susceptibility Testing
EPTB	Extrapulmonary Tuberculosis
EQA	External Quality Assurance
FCD	Fixed Dose Combination
HESN	Health Electronic Surveillance Network
HIV	Human Immunodeficiency Virus
HRE	Isoniazid, Rifampin, Ethambutol
IGRA	Interferon Gamma Release Assay
IPT	Isoniazid Preventive Treatment
LTBI	Latent Tuberculosis Infection
MDR-TB	Multi Drug Resistant Tuberculosis
MOH	Ministry of Health
MOTT	Mycobacteria other than tuberculosis
MTB	Mycobacterium tuberculosis
MTBC	Mycobacterial Tuberculosis Complex
NTP	National Tuberculosis Program
PHC	Primary Health Care
PHCC	Primary Health Care Center
PLHIV	People living with HIV
PPD	Purified Protein Derivative
PTB	Pulmonary Tuberculosis
RR-TB	Rifampicin Resistant Tuberculosis
TB	Tuberculosis
TST	Tuberculin Skin Test
VOT	Video observed treatment (VOT)
WHO	World Health Organization
WRD	WHO-recommended rapid diagnostic
XRD-TB	Extended Drug-Resistant Tuberculosis

1. Introduction

1.1. Microbiological preamble

Tuberculosis (TB) is a serious infectious disease caused by any mycobacterial organism that belongs to the *Mycobacterium tuberculosis complex* (MTBC), with *Mycobacterium tuberculosis* being the most commonly incriminated sub-species in human TB. Other members of the MTBC include *M. bovis*, *M. africanum*, *M. microti*, *M. canetti*, *M. caprae*, *M. orygis*, *M. pinnipedi*, which are called nontuberculous mycobacteria (NTM). More recently, a novel species was identified and classified under the nomenclature *M. mungi*. Although they share common phylogeny with *M. tuberculosis*, NTM subspecies are less likely to cause TB in human, with the exception of *M. africanum* and *M. microti* that have been isolated in some cases of human TB, notably in African patients. Otherwise, NTM sub-species are classified as opportunistic pathogens, and are principally responsible for animal TB, both in domestic, such as bovines (*M. bovis*) and goats (*M. caprae* and *M. bovis*), and wild animals, such as rodents (*M. microti*) and mongooses (*M. mungi*).

1.2. Transmission and Infection

Mycobacterium tuberculosis (MTB), also called Koch's bacillus, is a respiratory-borne infection. Bacilli are transmitted between humans by inhalation of the droplet nuclei coughed or sneezed out by an infected person. However, not all forms of TB are contagious, and the most contagious ones are pulmonary TB with a cavitary form and laryngeal TB. Other common extrapulmonary sites include lymph nodes, pleura, and osteoarticular system, all reputed to be noninfectious. Additionally, latent forms or inactive TB are noninfectious. The risk of contagion depends principally on 3 factors: (1) the degree of contact with the TB index patient, which is influenced by the exposure duration and physical distance within a shared air space; (2) the mycobacterial load in the respiratory secretions of the TB index patient; and (3) the immune status of the person in contact with the TB index patient (i.e. HIV-1 sero status, diabetes, malnutrition, immunosuppressive [anti-tumor necrosis factor- α], BCG vaccination status, etc.). The risk is greatest in case of prolonged, close household exposure to a person with an infectious TB form, notably having positive smear culture of pulmonary TB with a cavitary form.

Once inhaled, the mycobacteria reach the lungs and grow slowly over several weeks, during which the host's immune system is stimulated. In approximately 90% of people, the tuberculous bacilli remain in the tissues in a dormant state thanks to the defensive barrier that is built by the immune system, and the person remains asymptomatic. This phase or form is called latent tuberculosis (or tuberculosis infection). However, in a small number of cases (10%) the immune system fails to build a defensive barrier and to neutralize the TB mycobacteria, which eventually multiply causing progression of latent TB to an active disease. In a few cases, bacilli reach the blood stream during initial infection, thus being carried to other body organs such as bones,

lymph glands or the brain. These disseminated forms are more common in very young children and immunocompromised individuals.

1.3. Epidemiology of TB

1.3.1. Global situation

Based on the data published by the WHO in the global tuberculosis report (2020), TB remains a major global health issue. It ranks amongst the top 10 causes of mortality worldwide and is the leading cause of death from a single infectious agent (i.e. above HIV/AIDS). In 2019, an estimated 10.0 million people developed TB, among whom 1.2 million HIV-negative and an additional 208,000 HIV-positive people died from the disease, and most of these deaths are preventable.

Furthermore, despite the huge progress in therapeutic and preventive strategies, the yearly incidence of TB remains a disturbing fact. According to the WHO, the number of officially reported cases increased from 5.7–5.8 million new cases per year, in 2009-2012, to 10 million in 2019, drawing a positive slope from 2013. However, this ascending trend is mainly due to enhanced reporting of detected cases by both the public and private sectors in India, in addition to an upturn in notifications in Indonesia.

The other remarkable epidemiological aspect of TB is the growing discrepancy in the severity of the epidemic across countries. In 2019, there were fewer than 10 new cases per 100,000 population in most high-income countries, 150–400 in most of the 30 high TB burden countries, and above 500 in India, Indonesia and china

The African region is further burdened by a high rate of TB-HIV coinfection exceeding 50% in parts of southern Africa As an estimated 8.2of incident TB cases in 2019. The risk of developing TB among the 38 million people living with HIV was 18 times higher than in the rest of the global population.

Gender wise, TB incidence and mortality rates are higher among men; however, TB remains in the top three killers of women worldwide.

1.3.2. Situation in the Kingdom of Saudi Arabia

According to the 2019 National Report, the current TB situation in the Kingdom of Saudi Arabia shows that the total number of new and relapsed TB cases was 3004 cases, with an incidence of 8.7 per 100,000, and a therapeutic success rate of (89.9%). These estimates concord with the last WHO report showing approximately 3364 newly affected persons by TB in 2018, accounting for an incidence of 10 new cases per 100,000 population; while this incidence was 12 per 100,000 populations in 2017 according to the WHO.

Previously, the official data collected by the NTP had shown substantial decrease in the yearly incidence of TB over the past 5 decades (1970-2017), reflecting the significant efforts by the Kingdom to control the disease. A 93.2% decline was observed between 1970 (243 new cases per 100,000 population) and 1990

(16.6 new cases per 100,000 population), drawing a 4.7% downhill slope in the number of new cases, from year to year. Between 1990 and 2012, a slower decline was observed, to reach 8.6 to 12 new cases per 100,000 population in 2012. For the following five years (2012-2017), the incidence has stabilized at around 3,300 new cases annually, with an incidence lower than 12 new cases per 100,000 population per year.

Demographically, several factors are worth being highlighted in the epidemiological picture of TB in the Kingdom. The incidence is remarkably higher among non-nationals residing in KSA versus national citizens, with 10.9 versus 7.4 per 100,000 population in 2019, respectively. Migrant workers account for 47% of the smear-positive pulmonary TB cases, and 48% of extrapulmonary TB. Non-national population has an incidence rate nearly double that in Saudi population. Further, males represent approximately 71.2% of the notified cases, any form; and a significant proportion of the patients are young adults (aged less than 45 years), representing approximately 68.6% of notified TB cases, irrespective of gender. Clinically, nearly 86% of notified new TB cases in Saudi Arabia are bacteriologically confirmed pulmonary TB.

References

- Ahmad S. Pathogenesis, immunology, and diagnosis of latent *Mycobacterium tuberculosis* infection. *Clin Dev Immunol*. 2010; 2011:814943.
- Alexander KA, Laver PN, Michel AL, Williams M, van Helden PD, Warren RM, van Pittius NC. Novel *Mycobacterium tuberculosis* complex pathogen, *M. mungi*. *Emerging infectious diseases*. 2010 Aug;16(8):1296.
- Balasekaran V, Wiegand E, Taylor B, Smith D. Pathogenesis of tuberculosis: pathway to apical localization. *Tuber. Lung. Dis*. 75, 168–178 (1994).
- Bates JH. Transmission and pathogenesis of tuberculosis. *Clin Chest Med* 1980;1:167–174.
- Brudey K, Driscoll JR, Rigouts L, Prodinger WM, Gori A, Al-Hajj SA, Allix C, Aristimuño L, Arora J, Baumanis V, Binder L. *Mycobacterium tuberculosis* complex genetic diversity: mining the fourth international spoligotyping database (SpolDB4) for classification, population genetics and epidemiology. *BMC microbiology*. 2006 Dec 1;6(1):23.
- Dye C, Scheele S, Dolin P, Pathania V, Raviglione MC. Consensus statement. Global burden of tuberculosis: estimated incidence, prevalence, and mortality by country. WHO Global Surveillance and Monitoring Project. *JAMA*. 1999; 282(7):677–686.
- Fennelly KP, Martyny JW, Fulton KE, Orme IM, Cave DM, Heifets LB. Cough-generated aerosols of *Mycobacterium tuberculosis*: a new method to study infectiousness. *Am J Respir Crit Care Med* 2004;169:604–609.
- Forrellad MA, Klepp LI, Gioffré A, Sabio y Garcia J, Morbidoni HR, Santangelo MD, Cataldi AA, Bigi F. Virulence factors of the *Mycobacterium tuberculosis* complex. *Virulence*. 2013 Jan 1;4(1):3-66.
- Keane J, Gershon S, Wise RP, Mirabile-Levens E, Kasznica J, Schwieterman WD, Siegel JN, Braun MM. Tuberculosis associated with infliximab, a tumor necrosis factor α -neutralizing agent. *N Engl J Med* 2001;345:1098–1104.
- Loudon RG, Bumgarner LR, Lacy J, Coffman GK. Aerial transmission of mycobacteria. *Am Rev Respir Dis* 1969;100:165–171.

- Opie, E. L. & Aronson, J. D. Tubercle bacilli in latent tuberculous lesions and in lung tissue without tuberculous lesions. *Arch. Pathol. Lab. Med.* 4, 1–21 (1927).
- Sharma SK, Mohan A. Extrapulmonary Tuberculosis 4. *Mycobacterium tuberculosis: Molecular Infection Biology, Pathogenesis, Diagnostics and New Interventions.* 2019:37.
- Van Ingen J, Rahim Z, Mulder A, et al. Characterization of *Mycobacterium orygis* as *M. tuberculosis* complex subspecies. *Emerg Infect Dis* 2012; 18:653.
- Van Soolingen D, Hoogenboezem T, de Haas PE, et al. A novel pathogenic taxon of the *Mycobacterium tuberculosis* complex, Canetti: characterization of an exceptional isolate from Africa. *Int J Syst Bacteriol* 1997; 47:1236.
- Wirth T, Hildebrand F, Allix-Béguec C, Wölbeling F, Kubica T, Kremer K, Van Soolingen D, Rüsche-Gerdes S, Locht C, Brisse S, Meyer A. Origin, spread and demography of the *Mycobacterium tuberculosis* complex. *PLoS pathogens.* 2008 Sep;4(9).
- World Health Organization. Global Tuberculosis Report 2020. <https://apps.who.int/iris/bitstream/handle/10665/336069/9789240013131-eng.pdf>
- World Health Organization. WHO/HTM/TB/2009.411. Geneva, Switzerland: WHO; 2009. Global tuberculosis control: surveillance, planning and financing.

2. National Tuberculosis Program (NTP) in the Kingdom of Saudi Arabia

2.1. Background

In June 2016, the Kingdom of Saudi Arabia has adopted the End-TB strategy. This strategy consists of a TB-free World vision, with Zero death, Zero new cases and Zero burden related to TB. The End-TB strategy proposes a staged eradication plan of the global epidemic. An ultimate milestone was fixed in the year 2035, by the end of which TB mortality and incidence rates are anticipated to be reduced by 95% and 90%, by reference to 2015, respectively. These forecasts are completed by the maintain of a zero rate of TB-affected families facing catastrophic costs due to TB. The different milestones and their respective objectives are presented in **Table 2.1**. Further, End-TB strategy is based on three strategic pillars and underpinned by four key principles as are shown in **Box 2.1**, below.

Indicators	Millstones		Targets	
			SDG*	END TB
	2020	2025	2030	2035
Reduction in number of TB deaths Compared with 2015 (%)	35%	75%	90%	95%
Reduction in TB incidence rate compared with 2015 (%)	20%	50%	80%	90%
TB-affected families facing catastrophic costs due to TB (%)	0%	0%	0%	0%

* The United Nations Sustainable Development Goals (SDGs) include ending the TB epidemic by 2030 under Goal 3.

Table 2.1. End-TB strategy Objectives & milestones.

Box 2.1. Three pillars of End TB strategy

Pillar 1. Integrated, patient-centred care and prevention

- Early diagnosis of tuberculosis including universal drug-susceptibility testing, and systematic screening of contacts and high-risk groups.
- Treatment of all people with tuberculosis including drug-resistant tuberculosis, and patient support.
- Collaborative tuberculosis/HIV activities and management of co-morbidities.
- Preventive treatment of persons at high risk, and vaccination against tuberculosis.

Pillar 2. Bold policies and supportive systems

- Political commitment with adequate resources for tuberculosis care and prevention.
- Engagement of communities, civil society organizations, and public and private care providers.
- Universal health coverage policy and regulatory frameworks for case notification, vital registration, quality and rational use of medicines, and infection control.
- Social protection, poverty alleviation and actions on other determinants of tuberculosis.

Pillar 3. Intensified research and innovation

- Discovery, development and rapid uptake of new tools, interventions and strategies.
- Research to optimize implementation and impact, and promote innovations.

2.2. Elements of the National Tuberculosis Program (NTP)

In an own initiative, the Kingdom of Saudi Arabia implemented the NTP in the early 1970's, which was launched in successive phases to achieve national objectives. In 1998, DOTS Strategy was introduced and covered the whole population in the year 2000. Recently, the Kingdom was committed to the End-TB Strategy endorsed by the World Health Assembly of WHO in 2014. The Saudi NTP was based on three essential elements including early case detection, treatment and surveillance (**Figure 2.1**).

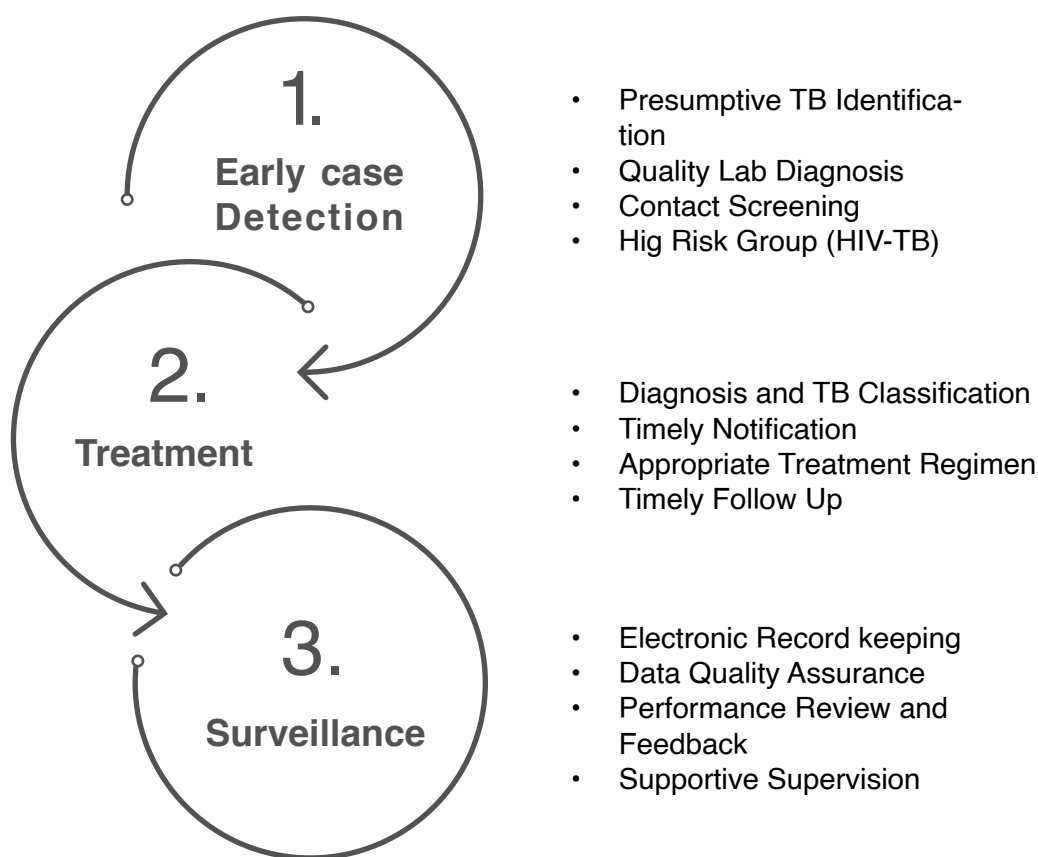

Figure 2.1. Elements of the National Tuberculosis Program of Saudi Arabia

2.3. Major policies of the NTP

The NTP was supported by a number of engaged policies and comprehensive guidelines aiming at enhancing case detection and promoting management efficiency. These are listed below:

- **Free Medical Management Services** for all residents and migrant workers, all age patients, and all type TB including Drug Resistant forms.
- **Passive case finding** in individuals who present at health facilities for symptoms that are compatible with or evocative for TB, and who are evaluated by health workers who recognize the symptoms of TB and have access to a reliable laboratory network performing regular quality control (internal and external)

and quality assurance systems. All health workers and volunteers are required to be aware of TB symptoms and how to proceed if TB is suspected, as well as about the circumstances in which a patient must be assessed for potentially drug-resistant TB.

- **Active case finding or systematic screening** for active tuberculosis among high risk groups. This consists of the systematic screening of predetermined target groups, using tests, examinations or other procedures that can be applied rapidly to identify active TB among the target group. Groups that are concerned with systematic screening include: household contacts and other close contacts of a tuberculous individual; people living with HIV, who should be systematically screened for active TB at each visit to a health facility; and people who tested positive for LTBI, who should be provided with tuberculosis preventive treatment. Individuals who test positive in the screening test will undergo confirmatory procedures including one or several diagnostic tests combined with clinical assessments, which together have high accuracy.
- **Cluster identification of risk groups in the community**, at different levels: 1) *Geographical clustering*: areas harboring subpopulations with poor access including underprivileged districts, urban slums, remote areas, impoverished families, refugees, homeless, etc.; 2) *Hospital outpatient and inpatient departments & PHCCs*: people previously treated for TB, people with an untreated fibrotic lesion, people living with HIV and people attending HIV testing, people with diabetes mellitus, people with chronic respiratory disease and smokers, undernourished, people with gastrectomy or jejunioileal bypass, people with an alcohol- or drug-use disorder, people with chronic renal failure, people on immunosuppressing treatments, elderly, and people in mental health clinics or institutions; 3) *Residential institutions*: prisoners and prison staff, people in deportation centres, residing in shelters, or other congregate settings such as the military, etc.; 4) *Immigration & refugee services*: immigrants from settings with a high prevalence of TB, People in refugee camps; and 5) *Workplaces*: health-care workers, miners or other workers exposed to silica, and any other workplaces with a high prevalence of TB.
- **Follow up of high-risk populations** who have latent TB infection with risk factors such as aging, tobacco use, and diabetes, as well as health care workers exposed to TB-infected individuals.
- **Providing preventive measures** along with preventive therapy as per the Ministry of Health policies to all household and close contacts of index patients.
- **Use of standardized treatment regimens.**
- **Patient centred care**, which consists of home-based or facility-based supply of all TB drugs, with respect of the patient's convenience and needs.
- **Maintained stock of all anti-TB drugs** for all ages and for all types of TB, including first and second line drugs for drug-susceptible and drug-resistant TB, respectively. Drugs should be available through Ministry of Health approved channels and stocked under optimal conditions.
- **Monitor routine collection of information sites regularly** in order to track a program's ongoing activities. This monitoring is carried out via the electronic surveillance system available (HESN) by calculating specific indicators, and is represented in the annual action plan of the NTP. There are two types of indicators: 1)

Operational indicators such as financial, human, and material resources used in a program/intervention (input); and 2) *Outcome indicators* such as impact monitoring (impact is the long-term, cumulative effect of programs/interventions over time on what they ultimately aim to change), input and output monitoring (results of program/intervention activities), and outcome monitoring (short-term and medium-term effect of an intervention's outputs).

- **Evaluation**, via supervisory visits and cohort analysis, which consists of assessing the programme implementation to provide reliable information that enable improving programs/interventions, identifying lessons learned, and informing decisions about future resource allocation. Impact evaluation includes NTP incidence variations, programs/interventions for at-risk populations, and outcome evaluation. It is done through cohort analysis of the regional TB programs and at the national level.
- **Provision of TB/HIV collaborative services**, through close partnership with National AIDS Program, is to establish the mechanisms for collaboration between TB and HIV control programmes. This policy aims to reduce the burden of TB in people living with HIV and to reduce the burden of HIV in TB patients. This is achieved through enhanced HIV prevention and care, along with additional collaborative TB/HIV activities addressing the interface of the intersecting TB and HIV co-infection, which should be carried out as part of the health sector response to the dual TB/HIV epidemic.
- **Implementation of national TB and HIV control strategies** that are based on international guidelines and are updated regularly.
- **Implementation of public and private mix** and ensuring close **coordination and cooperation** with governmental non-MOH facilities and private health care sector. Improving case detection and case management is achieved by bringing all patients, who are managed by diverse health care providers, under DOTS and by conducting supportive supervision.
- **Active case finding of TB** should be done in immigrants especially those coming from high burden regions, who seek long residency in the kingdom. A first assessment is carried out at the immigrant's home country, with re-examination at arrival to the Kingdom, as per the NTP guidelines, in collaboration with stakeholders at all levels.
- **Screening all health care professionals for latent TB** as per protocols of infection prevention and control policies.
- **All TB coordinators in all regions should ensure the implementation of the program guidelines** and are to be empowered through the appropriate channels in their regions.
- All TB coordinators should have their **annual plans under the strategic plan of NTP** and should seek NTP approval. Plans should involve monitoring and evaluation plan, building capacity, community engagement activities, and plans for specific occasions e.g. Hajj and Umrah.
- **Committees with different stakeholders** will be initiated and directed by NTP.

2.4. Organizational Structure

The NTP in Saudi Arabia has been based on the essential elements approved through official channels.

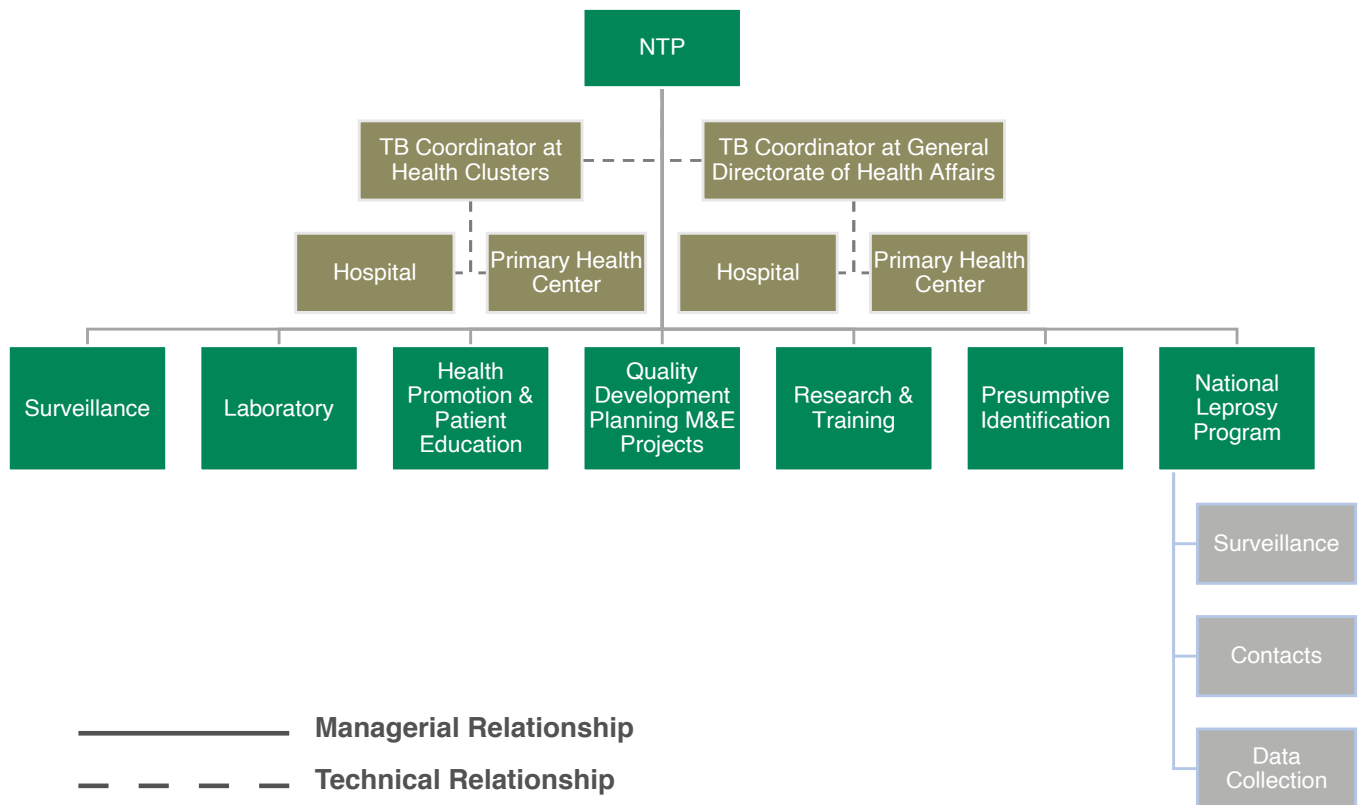

2.5. NTP central unit and regional TB program

NTP represents the central unit at the ministerial level of NTP, located in the Public Health Agency. It is headed by a manager who is a medical doctor with a medical doctorate degree in any relevant specialization. Regional TB program represents regional TB coordinators along with the regional team responsible of implementation of NTP guidelines.

2.6. Guidelines for National Tuberculosis Program

The guidelines are considered as a unified reference for technical and administrative affairs. They have to be reviewed and updated regularly according to the local and global circumstances, or every five years on a cyclical basis. The principal references to these guidelines are the World Health Organization documents. Should any specific policy be updated before the official guidelines update, a circular, email or official MOH communication tool from NTP central unit issued for that purpose is considered official. Any change in NTP policy will be communicated through an official circulate, via the official channels.

2.7. Case based electronic TB surveillance system

This is one of the main pillars of NTP, which constitutes a crucial tool to evaluate of the program performance. The procedures followed and forms used are consistent with those developed by the WHO, which are modified to coincide with the health system in the Kingdom.

2.8. Training

Training workshops and on-the-job training programs are regularly carried out to improve knowledge and keep high performance of personnel working within the program, at all levels. In addition, international training programs are held, with delivery of electronic competency certificates by the NTP central unit.

2.9. Laboratory services

Tuberculosis laboratory services are part of integrated tuberculosis programs. They are organized into three levels:

- The peripheral level: including all hospitals/primary health centers laboratories
- The intermediate level: regional/central laboratories
- The national laboratory

NTP will receive updates regarding the NTP laboratory services through official channels.

NTP can develop improvement projects and propose different tools or policies to improve laboratory services in the country.

In collaboration with the general directorate of laboratories and blood banks, NTP laboratory technical officer/s could conduct conjoint supervision for evaluation of TB laboratory network.

2.10. X-ray services

X-ray is one of the tools assisting in diagnosis of tuberculosis.

2.11. Treatment services

Treatment services are provided through specialized and general hospitals during the intensive phase of treatment, if admission is necessary. These services could also be provided by the outpatient clinics and PHCCs for patients who are not hospitalized during the whole period of treatment, ensuring patient based supervision and support in the community.

2.12. Medical supply and other similar service provider

NTP will follow up all needs of the program, including drugs and diagnosis requirement, and will update recording and reporting forms according to the regular statistical data in each region or district.

2.13. Structure of NTP and job description

The administrative structure of the NTP is composed of three levels: central (Central Unit), intermediate (Regional TB Coordinator and Cluster Coordinator), and peripheral level (Implementing Hospitals and Primary Health Centre).

2.13.1. The ministerial level of NTP (Central level)

The Central or ministerial level of NTP has the following functions, classified into 4 dimensions:

1) Policy making & Top-down coordination:

- Policy development and dissemination of technical notes and NTP manual.
- Update the program guidelines, forms and registers used by the program.
- Provision of technical support for policy implementation at all levels.
- Develop and manage specific strategies such as for DR-TB and TB/HIV.
- Partnership with HIV Infection Prevention and Control program, immigrants, smoking cessation clinics, non-MOH government facilities, diabetes clinics, private sector etc., to implement End-TB strategies.
- Coordinate between provinces/districts and NTP.
- Procurement and coordination of supplies distribution including drugs, equipment, documentation, health education materials in close collaboration with the General Directorate of Medical Supply.

2) Audit & Monitoring:

- Epidemiologic surveillance and data management.
- Field visits to ensure per plan implementation of the program activities at all levels.
- Periodic monitoring and evaluation of the program activities (recording & reporting, introduction of appropriate information technology, database management, epidemiological analysis, and program performance evaluation).
- Annual report of TB situation and progress achieved in all areas of work regarding TB control and prevention activities.

3) Education & Training:

- Develop and conduct training plan and educational workshops.
- Health education in collaboration with other specialized directorates.

4) Research & Development:

- Identify and disseminate research priorities in cooperation with national and international academic facilities.
- Develop, monitor and evaluate improvement projects, and follow up the outcome indicators.

2.13.2. Intermediate level (Regional coordinator/District level)

A regional coordinator is appointed at the head of regional TB program, at each province/district level. The regional coordinator should be a medical officer from the following: public health physician, pulmonologist, internist or general practitioner. The regional coordinator is part of the Directorate of Health Affairs and has the following missions:

- Develops a yearly district operational plan based on the national strategic plan.
- Keeps the district tuberculosis register, records patients' information, laboratory results and treatment outcome in the due time, and assigns the unique tuberculosis code that will be used by the treating facility.
- Keeps records, reports, statistical data and circulars, which should be regularly reviewed for optimal utilization.
- Monitors patients' adherence to the recommended treatment protocol and trace defaulted patients.
- Periodically reviews the TB laboratory registers and checks for primary defaulters and makes necessary actions to bring them back to adequate adherence.
- Supervises the implementation of technical and administrative actions regarding early detection, administration of standard chemotherapy and follow-up of TB patients according to a pre-set scheduled plan, and prepares reports about these activities.
- Ensures implementation of the public preventive measures, such as screening of contact subjects and provision of preventive chemotherapy.
- Regularly updates information in HESN.
- Supervises the implanting units for all aspects of TB control.
- Supervises active case finding among high risk groups.
- Prepares quarterly and annual reports to review TB situation, in the respective province/district, to the district tuberculosis control.
- Develops and conducts a regional training plan.
- Coordinates between the regional and the central unit.
- Takes over advocacy, communication and health education on provincial/ district level.
- Builds partnership with non-MOH government facilities, private sector, infection control responsible officers, HIV program, and diabetes clinics.
- Ensures regular drug collection by the patients registered in the district and follow-up of patients who are transferred to another district.
- Ensures and supervises management and distribution of supplies for TB control activities in the province/district.
- Submits needs report (treatment and equipment) to the central unit.
- Contributes in the regular meetings held by the central unit.

2.1.3.3. Peripheral level (Implementing units)

This level includes all the facilities that provide care for TB patients and apply the anti TB preventive measures. It includes:

- Primary health care centers (PHCCs)
- Hospitals
- Non-MOH health care facilities
- Private health care sector

Functions and responsibilities of the Primary Health Care Centers (PHCCs)

Thanks to their nationwide distribution, PHCCs have an important role in TB control, and to which the following functions are attributed:

- Identification and referral of TB suspected cases for diagnosis.
- Ensuring the presentation at the target health facilities of the referred cases.
- Keeping updated register of suspected cases.
- Collection and testing by gene Xpert of sputum samples from suspected cases, if techniques available; or refer the patient to other facility as per MoH policies for diagnosis and treatment.
- Following up the referred TB patients and ensuring their adherence to the treatment protocol, by implementing patient centred care via the mobile teams assigned to the PHCC.
- Enabling sputum samples collection from patients under treatment as per schedule (i.e. at 2, 4, 6 months following the diagnosis) and sending the samples to the laboratory for examination.
- Coordinating with the TB laboratory for obtaining the results of smear samples sent for examination.
- Tracing defaulted TB patients in collaboration with the province/district coordinator.
- Conducting epidemiologic survey for contact subjects and applying the required preventive measures
- Referring suspected TB cases for further investigations.
- Keeping updated register of contacts subjects residing in the PHCC coverage area.
- Submitting periodic reports to the province/district coordinator on suspect identifications, contacts information, sputum smear results and treatment outcomes.
- Providing health education for the patients, contacts and community.
- PHCCs could substitute TB clinics or centres, if the latter are closed or not available, subject to specific requirement and after approval of the regional TB program and NTP.

Functions and responsibilities of outpatient clinics assigned for TB management

The following tasks are assigned to the outpatient clinics in hospitals that could be attended by individuals with any TB related complaint, who have no indications for hospitalization:

- Identify presumptive TB cases among all attendees.
- Investigate patients with symptoms indicative or presumptive for TB, to confirm or exclude active TB disease.
- Prescribe treatment protocol for bacteriologically confirmed pulmonary TB, standardly using either Xpert MTb/Rif or rapid culture techniques. Smear microscopy is not recommended for diagnosis, but only for the follow-up of TB patients during treatment.
- Perform smear microscopy for follow-up during treatment.
- Ensure patient adherence to treatment by providing incentives and enablers.
- Defaulter tracing.
- Ensure regular supply of drugs and logistics, such as sputum containers, stain, forms and registers, drugs, etc.
- Contribute in contact screening and provision of TB preventive therapy to all household contacts, after excluding active TB disease.
- Follow-up TB patients referred from other facilities.
- Ensure updated patients' information, including treatment card.
- Ensure no treatment card is opened without TB code.
- Keep an updated register of presumptive TB cases.
- Keep an updated register of contacts.

Responsibilities and functions of non-MoH health care facilities

Non-MoH health care facilities include all governmental care facilities that are not under the direction of the ministry of health. Non-MoH are committed to follow the adopted national guidelines of TB control and to contribute in the activities aiming at preventing transmission of TB in the community. Each facility should assign a person to be the focal point for communication with the NTP in the regional or central unit of the ministry of health. Responsibilities and functions of Non-MoH facilities are the same to those of MoH-facilities, besides the contribution of academic ones in the research field, in collaboration with the NTP.

Functions and responsibilities of the Private sector

The role of the private health centers and private clinics is restricted to identification and referral of suspected patients to the nearest MoH-health facilities for free of charge diagnosis and treatment. Nevertheless, some specific points and responsibilities need to be underlined:

- In case that the private center has facilities to carry out smear microscopy gene Xpert MTB/Rif, sputum results should be communicated with the patient.
- In case that the private center does not possess qualified personnel and well-equipped laboratory, it remains of its responsibility to identify TB suspect cases and refer them to the nearest MOH-health facilities for free of charge diagnosis and treatment
- In private hospitals that have qualified personnel, equipment for diagnosis and requirements for tuberculosis patients' isolation, the option is open to isolate and treat confirmed TB cases in the private hospital, by desire of the patient. In this case, coordination between the private hospital and the district tuberculosis coordinator is essential to ensure regular intake of treatment by the patient and to apply preventive measures for contacts.
- Keep tuberculosis register for all TB patients treated in the facility.
- Enroll the facility TB laboratory in internal and external quality assurance procedures.
- Private health care facilities diagnosing and treating TB patients must notify the province/district coordinator of all TB patients managed by the facilities, their smear results and treatment outcome, otherwise formal penalties as defined by legislations have to be applied.
- Additionally, private health care facilities should be included in the training programs on TB control at the regional level.

2.14. Supporting services

2.14.1. Laboratories

Tuberculosis bacteriological examination is one of the fundamental aspects of NTP, as it is mandatory for both the confirmation of diagnosis and the monitoring of treatment efficacy. The bacteriological examinations should be performed using standard procedures and according to optimal quality requirements. Tuberculosis laboratory services are organized into three levels as follow:

The peripheral TB laboratory

These laboratories are equipped to perform sputum smear microscopy, using non-concentrated sputum specimen. The peripheral TB laboratories have the following functions:

- Receipt of specimens and dispatching results.
- Preparation and staining of smears.
- Performing gene Xpert MTB/Rif or Xpert Ultra.
- Recording microscopy results.
- Internal quality control.
- Maintenance of laboratory register.
- Management of reagents and laboratory supplies.

- Sending feedback with the smear and gene Xpert results to the referring physician.
- Providing quality data of laboratory results and quality check.
- Providing all necessary data required at any point of time.

The intermediate laboratory, located at public health laboratories in big hospitals or in cities.

These laboratories are equipped to perform staining of concentrated specimens, culture of clinical specimens and differentiation between *M. tuberculosis* complex (MTBC) and other mycobacteria and speciation of MTBC. The intermediate laboratory has the following functions:

- All functions of the peripheral level laboratory.
- Performing solid and liquid cultures and identification of mycobacteria.
- Performing mycobacterial phenotyping and molecular susceptibility testing.
- Supervision and support of the peripheral tuberculosis laboratories.
- Participation in personnel training of the peripheral tuberculosis laboratories.
- Regular needs assessment and forward to the national reference laboratory.
- Performing External Quality Program and External Quality Assurance (EQA).
- Keeping an updated laboratory register.
- Ensuring availability of quality data.
- Quality improvement and performance testing of microscopy at peripheral TB laboratories.

The central reference TB laboratories

Central laboratories are equipped to perform sputum microscopy, mycobacterial culture on both solid and liquid media, drug susceptibility testing, and species identification. They carry out all functions of the peripheral and intermediate levels laboratories, plus the following functions:

- Identification of mycobacteria other than tuberculosis (MOTT).
- Technical control of and repair services for laboratory equipment.
- Updating and dissemination of manuals on bacteriological methods for diagnosing tuberculosis.
- Development and dissemination of guidelines on care and maintenance of microscopes and other equipment used in tuberculosis bacteriology.
- Development and dissemination of guidelines on tuberculosis laboratory supervision and quality assurance.
- Collaboration with the central unit of NTP in defining technical specifications for equipment, reagents and other materials used in bacteriological investigations.
- Training of intermediate laboratories' staffs in bacteriological techniques and support activities, i.e. training, supervision, quality assurance, safety measures and equipment maintenance.
- Supervision of intermediate laboratories regarding bacteriological methods, as well as regarding their support provided to peripheral laboratories, particularly in training and supervision.
- Quality assurance of microscopy and culture performed at intermediate laboratories.
- Surveillance of primary and acquired mycobacterial drug resistance.
- Contribution in operational and applied TB-related research.
- Periodic audit of the intermediate and peripheral level laboratories through a standard check list.
- Performing all specialized tests that are not available at other levels, e.g. whole genome sequencing, phage typing, etc.
- Providing any required data at any point of time.

2.14.2. X-ray services

X-ray units have a supportive role in the diagnosis of TB and have the following tasks:

- Examining all patients with presumed TB status, those under treatment and need follow up, or as per treating physician request.
- Recording the findings in the X-ray register with red color. The district TB-code of the patient should be also registered, if available, for easy reviewing.
- Preparing reports and forwarding them to the facility that referred the patient.
- Filing X-ray films to facilitate further revision.

2.14.3. Drug supply policy:

- To prevent the emergence of drug resistant strains that may result from anti-tuberculosis drugs misuse, anti-tuberculosis drugs distribution is prohibited at the private sector, except after coordination with the Health Affairs Directorates.
- Estimation of the required amounts of drugs should be based on the number of cases and the available amount in district stores; drug stocks will be secured and refilled as per the appropriate channels, three months ahead of shortage.
- The drug stores should be regularly checked for expiry dates, at all levels, starting from medical supply to the PHCs' pharmacies.



3. Diagnosis of Tuberculosis

3.1. Algorithm 1: Universal patient access to rapid testing regarding MTB detection and rifampicin resistance evaluation

3.1.1. Scope and specifications

In Decision Tree for **Algorithm 1**, the Xpert MTB/RIF test is used as the initial diagnostic test for all adults and children individuals with signs or symptoms of pulmonary TB or with chest X-ray abnormalities suggestive of TB, regardless of HIV status. The algorithm is modified according to the needs of KSA health care system, by accommodating smear microscopy along with Xpert.

- The Xpert MTB/RIF test is recommended as the initial diagnostic test for persons being evaluated for TB. This includes all newly presenting symptomatic persons, those who are on therapy or have been previously treated, notably patients who are evaluated for possible rifampicin-resistant TB (e.g., non-converters at the end of the intensive phase of treatment), or those with a new or continuing episode of TB including relapsed and lost to follow-up patients.
- The Xpert MTB/RIF test is also recommended for use in persons being evaluated for extrapulmonary TB, although it is not appropriate for all types of extrapulmonary specimens. It is recommended for use with CSF, lymph nodes and other tissue samples; however, it has low sensitivity for pleural fluid specimens and data are limited regarding its sensitivity with stool, urine or blood specimens. See the WHO Policy Update: *Xpert MTB/RIF assay for the diagnosis of pulmonary and extrapulmonary TB in adults and children for a discussion of the use of the Xpert MTB/RIF assay with extrapulmonary specimens*.
- The Xpert MTB/RIF test is **NOT** recommended as a test to monitor treatment; instead, microscopy and culture should be used according to national guidelines.
- The algorithm describes the collection of one initial specimen to be used for Xpert MTB/RIF testing and the collection of additional specimens as needed. Operationally, it is recommended to routinely collect two specimens from each patient (e.g., spot and morning sputum samples or two spot specimens), in case if a second specimen for additional testing is needed. The first specimen should be promptly tested using microscopy and the Xpert MTB/RIF test. The second specimen may be used for the additional testing described in the algorithm (e.g., repeat Xpert MTB/RIF testing) or for smear microscopy as a baseline for treatment monitoring.
- If more than one specimen cannot be collected (e.g., only one lymph node biopsy can be collected), the algorithm should be modified to prioritize testing using the Xpert MTB/RIF test and consider using any portions of the sample remaining after the Xpert MTB/RIF test for other testing. Clinical decisions should be made based on clinical judgement and the results of available laboratory tests.
- The GeneXpert software provides Xpert MTB/RIF assay results as 'MTB not detected'; 'MTB detected (high, medium, low, or very low), rifampicin resistance detected, not detected, or indeterminate'; 'no result'; 'error'; or 'invalid'. In this document, each of the semi-quantitative categories of MTB detected is considered as bacteriological confirmation of TB.

- For HIV positive persons with severity signs or have CD4 counts ≤ 100 cells/ μl , who are evaluated for TB, a urine LF-LAM assay may also be used (see **Algorithm 4**).

Algorithm 1 is the preferred algorithm for testing to detect MTB in individuals being evaluated for pulmonary TB. It incorporates the goals of the End-TB Strategy for the use of WRDs and universal DST. This algorithm is feasible when a GeneXpert instrument is available on site or when Xpert MTB/RIF testing can be accessed through a reliable referral system with acceptable turnaround time. This algorithm may also be used for the detection of MTB using cerebrospinal fluid (CSF), lymph nodes and other tissue types from persons being evaluated for extrapulmonary TB.

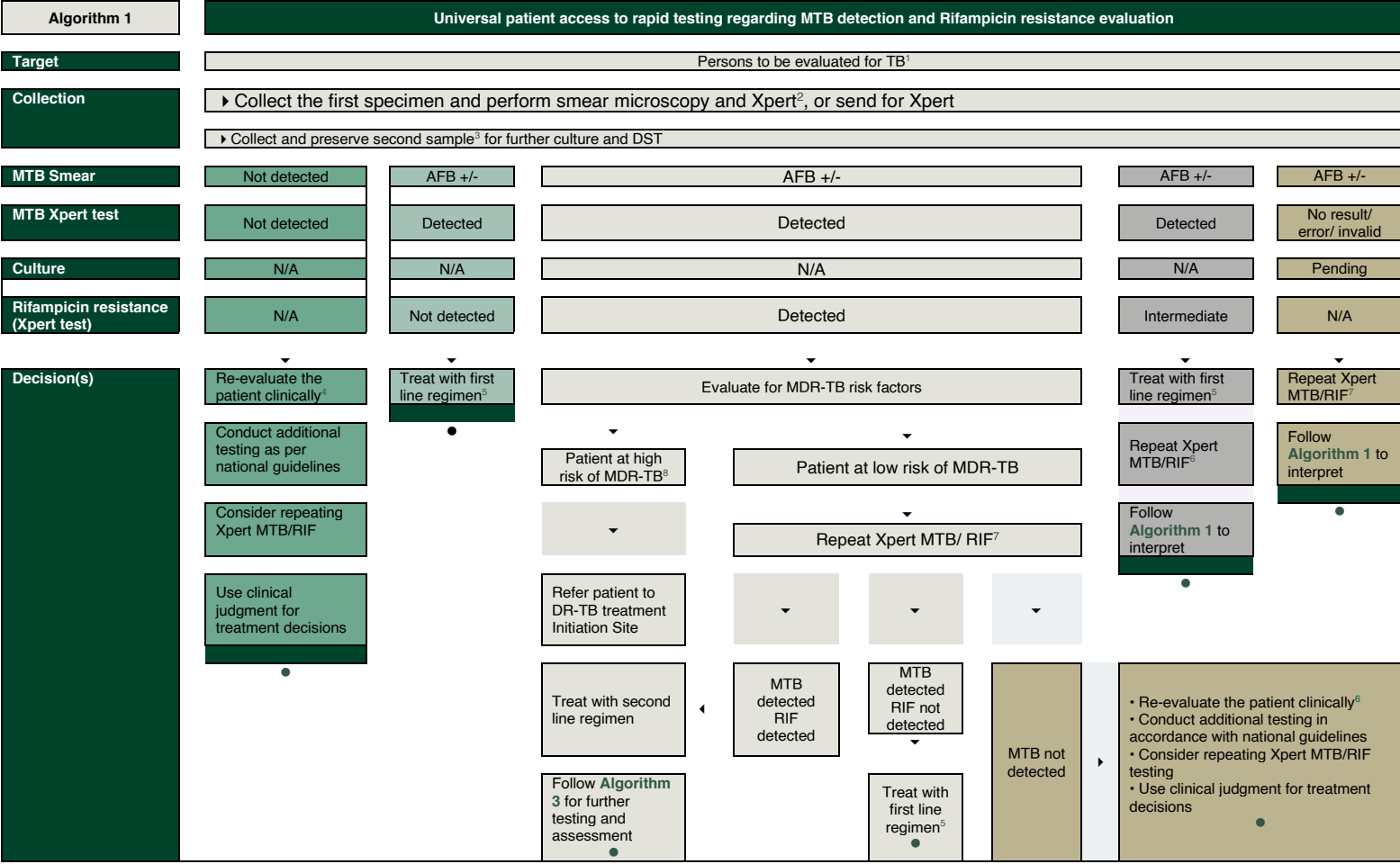

Note: The above diagram is adopted in Kingdom of Saudi Arabia, by modifying some steps while keeping the original information obtained from the reference.
 AFB: Acid-Fast Bacillus, DST: Drug-susceptibility testing, TB: Tuberculosis, MTB: mycobacteria tuberculosis, DR-TB: drug resistant tuberculosis, MDR: Multidrug resistant.

1 Persons to be evaluated for TB include adults and children with signs, symptoms or chest X-ray abnormalities suggestive of TB. This algorithm also applies for the detection of MTB using CSF, lymph node and other tissue specimen from persons being evaluated for extrapulmonary TB. For HIV positive persons with CD4 counts ≤ 100 cells/ μ l or those with severe disease, see **Algorithm 4**.

2 The new generation Xpert MTB/RIF Ultra assay (Ultra) uses the same semi-quantitative categories used in the Xpert. Treatment decision is based on clinical judgment, MTB/RIF assay results, and an additional semi-quantitative category “trace call” that corresponds to the lowest bacillary burden for MTBC detection. If MTB is detected with a “trace call”, then no interpretation can be made regarding rifampicin resistance and results should be reported as MTB detected, trace, RIF indeterminate (Follow section on “MTB detected, rifampicin indeterminate” under Algorithm 1). The “trace call” positive result is sufficient to initiate therapy in those with known or suspected HIV infection, children and patients with extrapulmonary samples. For other categories of patients, repeating test may be considered with use of second Ultra test for clinical decisions and patients’ follow-up. (See GLI Planning for country transition to Xpert MTB/RIF Ultra Cartridges).

3 Programs may consider collecting two specimens upfront. The first specimen should be promptly tested using microscopy and Xpert MTB/RIF test. The second specimen may be used for the additional testing described in this algorithm. For persons who are evaluated for pulmonary TB, sputum is the preferred specimen.

4 Further investigations for TB may include chest X-ray, additional clinical assessments, and clinical response following treatment with broad-spectrum antimicrobial agents, eventually with repeated Xpert MTB/RIF testing, or culture.

5 Patients should be initiated on a first-line regimen according to national guidelines. A sample may be sent for molecular or phenotypic DST for isoniazid, particularly if the patient has been previously treated with isoniazid or if there is a high prevalence of isoniazid resistance not associated with rifampicin resistance (i.e., isoniazid mono- or poly-resistance) in the setting; or for DST for rifampicin if rifampicin resistance is still suspected.

6 Repeat Xpert MTB/RIF test at the same testing site, using a new specimen. Use the rifampicin result of the second Xpert MTB/RIF test in this algorithm for decision regarding the regimen choice (first or second line regimen).

7 Repeat Xpert MTB/RIF test at the same testing site, using a new specimen. Interpret the result of the repeat test as shown in this algorithm. Use the result of the second Xpert MTB/RIF test for clinical decisions.

8 Patients at high risk for multidrug-resistant TB (MDR-TB) are those who were previously treated including patients who were lost to follow-up, relapsed, failed a treatment regimen, and non-converters (smear positive at end of intensive phase); in addition to MDR-TB contacts and any other MDR-TB risk groups identified in the country.

3.1.2. Operational procedures for Algorithm 1

Step 1

Collect a good quality specimen and transport it to the testing laboratory. As per national policy of KSA, smear microscopy is carried out in combination to Xpert MTB/RIF test. For persons being evaluated for pulmonary TB, specimen samples are collected from induced or expectorated sputum (preferred), bronchoalveolar lavage, gastric lavage, or gastric aspiration. Data are limited for the sensitivity of the Xpert MTB/RIF with other samples such as nasopharyngeal aspirates, string test samples, or stool samples.

Step 2

Irrespective to the smear microscopy result, if MTB detected and rifampicin resistance not detected in the Xpert MTB/RIF test:

- a. The patient should be initiated on appropriate regimen using first-line TB drugs according to national guidelines.
- b. Regional TB program may request additional DST in the following cases:
 - i. Molecular (e.g., FL-LPA) or phenotypic DST for isoniazid is of particular interest. It is principally indicated in patients who have been previously treated with isoniazid or in settings with high prevalence of isoniazid resistance that is not associated with rifampicin resistance (i.e., isoniazid mono-resistance or poly-resistance, not MDR-TB).
 - ii. Molecular or phenotypic DST for rifampicin resistance may be requested if the patient is considered to be at risk of having MDR-TB, regardless of the initial Xpert MTB/RIF result. False rifampicin-susceptible Xpert MTB/RIF results are rare but have been observed in 1–5% of TB cases, which were tested in various epidemiologic settings. By contrast, phenotypic DST for rifampicin, especially using liquid culture, is associated with a higher proportion of false susceptible results.
- c. If additional molecular or phenotypic testing is done:
 - i. The molecular and phenotypic testing may be done in different laboratories. In that case, these tests should be initiated simultaneously; i.e. no need to wait for the results of the one before initiating the other test.
 - ii. The molecular and phenotypic DST may be done using the specimen (direct DST) or using bacteria grown by culture (indirect DST). While direct DST has a much shorter turnaround time, indirect phenotypic DST may be preferred for technical reasons.
 - iii. A rapid molecular test is preferred. Currently, FL-LPA is the only WHO-approved rapid molecular test for isoniazid resistance. FL-LPA can identify *inhA* and *katG* mutations, which guides clinicians on the composition of isoniazid-resistant TB regimen. DNA sequencing has proven useful in many cases but has not yet been evaluated by WHO.
 - iv. Culture-based phenotypic DST for isoniazid and rifampicin resistance requires 3 to 8 weeks to produce a result. Phenotypic DST may be useful for the evaluation of patients with a negative FL-LPA result, particularly in populations with a high pre-test probability for resistance to isoniazid.

Step 3

If the Xpert MTB/RIF test result is MTB detected and rifampicin resistance detected, an MDR-TB risk assessment is needed. Patients at high risk for MDR-TB are those who have already been treated including those who were lost to follow-up, have relapsed, or failed a treatment regimen; in addition to non-converters (smear positive at end of intensive phase), contacts of MDR-TB patients, and any other MDR-TB risk groups identified in the country.

- a. If the patient has high risk of MDR-TB, the detected rifampicin resistance result is considered a definitive status. Rifampicin-resistant (RR-TB) or MDR-TB should be initiated, according to national guidelines. **Algorithm 3** should be applied for additional testing.
- b. If the patient has low risk of MDR-TB, repeat the Xpert MTB/RIF test with a second sample. If FL-LPA is available at the site and the sputum specimen is smear positive, FL-LPA can be used to confirm the rifampicin-resistant result.
 - i. If the second Xpert MTB/RIF test confirms rifampicin resistance, initiate an MDR-TB regimen according to national guidelines and follow **Algorithm 3** for additional testing.
 - ii. If the second Xpert MTB/RIF does not confirm rifampicin resistance (not detected), initiate treatment with a first-line regimen according to national guidelines. False positive rifampicin-resistance results are commonly due to laboratory or clerical errors and rarely to technical performance of the assay. Therefore, the result of the second test is considered the correct one, and the first test result is assumed to be a laboratory or clerical error.
- c. For all patients with RR-TB or MDR-TB follow Algorithm 3

Step 4

If the Xpert MTB/RIF test gives a result of MTB detected, rifampicin indeterminate, the Xpert MTB/RIF test should be redone with a second specimen, at the same testing site.

- a. The initial result (MTB detected) should be considered as bacteriological confirmation of TB. The patient should be initiated on appropriate regimen using first-line TB drugs, according to national guidelines.
- b. If the result of the second Xpert MTB/RIF test is MTB detected, rifampicin resistance not detected, follow *Step 2*. If it is MTB detected, rifampicin resistance detected, follow *Step 3*.
- c. An Xpert MTB/RIF result “MTB detected, rifampicin indeterminate” often occurs in specimens containing very few bacteria. Consequently, testing a second sample, which also may contain very few bacteria, may generate an indeterminate rifampicin resistance result as well - or even MTB not detected. In such situation, additional investigations such as culture and phenotypic DST may be necessary to confirm or exclude resistance to rifampicin, because indeterminate result provides no information on resistance.

Step 5

If the Xpert MTB/RIF test result is MTB not detected, re-evaluate the patient and conduct additional testing in accordance with national guidelines.

- a. Further investigations for TB may include chest X-ray, additional clinical assessments, and monitoring of clinical response following treatment with broad-spectrum antimicrobial agents (fluoroquinolones should not be used). Eventually, additional Xpert MTB/RIF testing or culture can be considered. Testing for isoniazid resistance using FL-LPA or phenotypic DST is advised (See **Algorithm 1**).

- b. Consider the possibility of clinically defined TB (i.e., no bacteriological confirmation). Use clinical judgement for treatment decisions.

If the Xpert MTB/RIF test does not give a result or gives “error” or “invalid” result, the Xpert MTB/RIF test should be repeated with a second specimen, at the same testing site. Optionally, FL-LPA can be used for the repeat testing, if available at the site, in case that the second specimen is smear positive; however, repeat Xpert MTB/RIF testing is preferred.

This algorithm relies on Xpert MTB/RIF testing of samples for the detection of MTB and assessment of susceptibility to rifampicin. In some cases, retesting during follow-up testing may be necessary to ensure well-informed clinical decisions. However, discordant results may happen, usually when comparing culture-based results with molecular results. Each discordant result will need to be investigated on a case-by-case basis.

Specific considerations

Discrepancy in MTB detection between Xpert MTB/RIF test and culture

a.1. Xpert MTB/RIF **MTB detected, culture negative.**

- i The Xpert MTB/RIF result should be used to guide treatment decision pending additional testing.
- ii The Xpert MTB/RIF result should be considered as bacteriological confirmation of TB if the sample was collected from a person who was not recently receiving treatment with anti-TB drugs.
- iii Cultures from persons with pulmonary TB may be negative for a variety of technical reasons, such as inadequate transport or processing conditions that inactivated the tubercle bacilli, culture contamination, and inadequate testing volume. Further, the discrepancy between Xpert MTB/RIF and culture results may result from laboratory or clerical error.
- iv Follow-up actions may include re-evaluating the patient for TB, reassessing the possibility of prior or current treatment with anti-TB drugs (including fluoroquinolone use), evaluating the possibility of laboratory or clerical error, and repeating culture.

a.2. Xpert MTB/RIF **MTB not detected, culture positive.**

- i Treatment decision should be based on the culture result.
- ii The culture-positive result should be considered as bacteriological confirmation of TB because culture is the current gold standard for the laboratory confirmation of TB. Using a sputum specimen, Xpert MTB/RIF has a pooled sensitivity of 89% for detecting MTB compared to culture.³ Xpert MTB/RIF sensitivity is lower in people living with HIV (PLHIV), children, and other specimen types such as CSF.
- iii False positive cultures can result from a variety of causes such as cross-contamination in the laboratory or sample labelling problems. In well-functioning laboratories, such errors are rare.
- iv Follow-up actions may include re-evaluating the patient for TB, monitoring response to anti-TB therapy, conducting additional testing using Xpert MTB/RIF, processing culture of additional samples, and evaluating the possibility of laboratory or clerical error.

b. Discrepancy in rifampicin resistance profile between Xpert MTB/RIF and phenotypic DST

b.1. Xpert MTB/RIF MTB detected, rifampicin resistance detected; rifampicin susceptible by phenotypic DST.

- i The Xpert MTB/RIF result should be used to guide treatment decisions pending additional testing.
- ii Certain mutations are known to generate such discordant result, i.e. false susceptible phenotypic result, particularly in BACTEC™ MGIT™ system. Patients infected with strains carrying these mutations often fail treatment with rifampicin-based first-line regimens.⁴
- iii In some settings with low MDR-TB prevalence, silent mutations have been observed to generate a false-resistant Xpert MTB/RIF profile, but these tend to be very rare.
- iv Follow-up actions may include DNA sequencing, phenotypic DST using solid media, and evaluating the possibility of laboratory or clerical error.

b.2. Xpert MTB/RIF MTB detected, rifampicin resistance not detected; rifampicin resistant by phenotypic DST.

- i Treatment decisions should be based on the phenotypic DST result.
- ii False rifampicin-susceptible results in Xpert MTB/RIF are rare, and have been observed in 1–5% of TB cases tested in various epidemiologic settings. Mutations in the regions of the *rpoB* gene account for 95–99% of rifampicin resistance in Xpert MTB/RIF tests. In the remainder proportion, a false negative result (rifampicin resistance not detected) in Xpert MTB/RIF test may arise from mutations outside the sampled region.
- iii Follow-up actions may include DNA sequencing, repeating the phenotypic DST, and evaluating the possibility of laboratory or clerical error.

3.2. Algorithm 2: Limited patient access to rapid testing regarding MTB detection and rifampicin resistance evaluation – Interim decision tree based on rapid testing for priority populations

3.2.1. Scope and specifications

Algorithm 2 is an interim solution towards meeting the goals of the End TB Strategy. According to this algorithm, the use of Xpert MTB/RIF testing is restricted for priority populations including adults being evaluated for HIV-associated TB or MDR-TB and children, as described in the WHO Policy Update: *Xpert MTB/RIF assay for the diagnosis of pulmonary and extrapulmonary TB in adults and children*.

Algorithm 2 is suitable when no GeneXpert instrument is available on site, with no access to a reliable referral system with short turnaround time for Xpert MTB/RIF testing.

Algorithm 2 may also be applicable in case that resources do not permit testing all samples with the Xpert MTB/RIF test. As the Kingdom moves toward enhancing access to rapid diagnostic and universal drug-susceptibility testing and as access to prompt Xpert MTB/RIF testing becomes available to majority sites (either in-site implementation or enabled sample referral system), **Algorithm 1** should be implemented.

Decision tree for **Algorithm 2** is applicable in case that Xpert MTB/RIF test is not available for all persons being evaluated for TB, because of resource limitations or lack of testing capacity. In such case, Xpert MTB/RIF test should be reserved with priority for specific cases (priority populations), and smear microscopy is used for other patients being evaluated for TB.

Otherwise, **Algorithm 1** (not **Algorithm 2**) should be followed in any setting where Xpert MTB/RIF testing is available on site or when Xpert MTB/RIF testing can be accessed through a reliable referral system with short turnaround time.

- Many countries have not yet built the capacity to conduct Xpert MTB/RIF testing for all persons being evaluated for TB. In such situations, Xpert MTB/RIF testing focuses on testing the priority populations identified in the WHO *Policy Xpert MTB/RIF assay for the diagnosis of pulmonary and extrapulmonary TB in adults and children*, and builds towards universal access. The priority populations are adults being evaluated for HIV-associated TB, MDR-TB, and children.
- **Algorithm 2** may also be used for persons being evaluated for extrapulmonary TB. See Decision Tree for **Algorithm 1** for sample types and considerations.
- See Annexes 14 and 15 of the WHO *Consolidated guidelines on the use of antiretroviral drugs for treating and preventing HIV infection. Recommendations for a public health approach – Second edition* for detailed algorithms for the management of persons being evaluated for HIV-associated TB.

The TB-LAMP test may be used as a replacement for smear microscopy for the detection of MTB in adults and children with signs or symptoms suggestive of TB. However, TB-LAMP should not replace the use of

Xpert MTB/RIF or other rapid molecular tests for MTB and rifampicin resistance detection, especially among populations at risk of MDR-TB, when there are sufficient resources and infrastructure to support their use. Also, TB-LAMP should not replace the use of rapid molecular tests that have a higher sensitivity for detection of MTB among PLHIV.

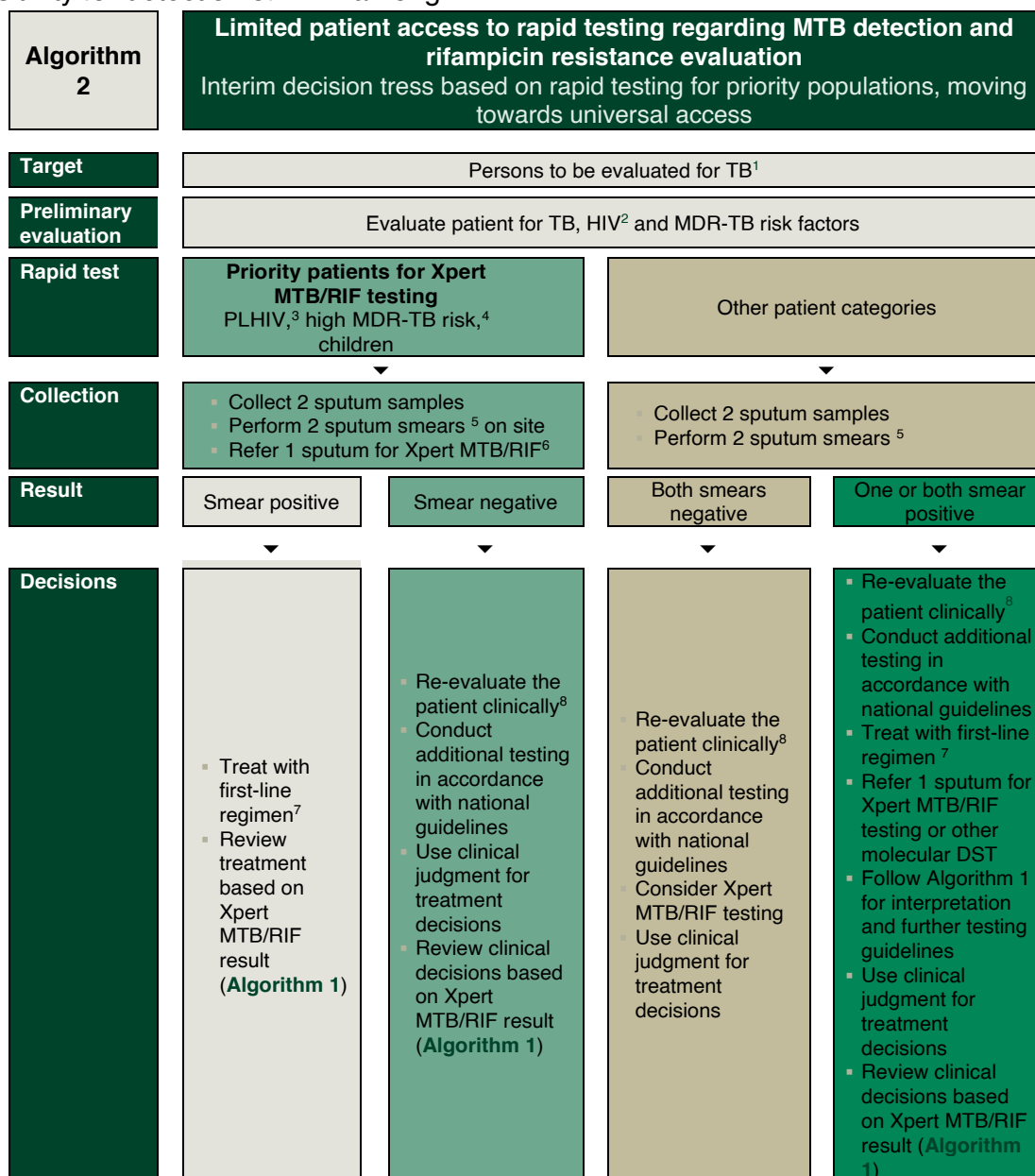

- 1 Persons being evaluated for TB include all persons with signs, symptoms or chest X-ray abnormalities suggestive of TB. This algorithm may also be used for persons being evaluated for extrapulmonary TB. See footnotes to **Algorithm 1**.
- 2 For HIV positive persons with CD4 counts ≤ 100 cells/ μ l or with severe disease, see **Algorithm 4**.
- 3 PLHIV include persons who are HIV positive, as well as those with unknown HIV status who present with strong clinical suspicion for HIV infection in settings with high prevalence of HIV or being member of a risk group for HIV. For all people with unknown HIV status, HIV testing should be performed according to national guidelines.

- 4 Patients at high risk for MDR-TB are those who were previously treated including patients who were lost to follow-up, relapsed, failed a treatment regimen, and non-converters (smear positive at end of intensive phase); in addition to MDR-TB contacts and any other MDR-TB risk groups identified in the country .
- 5 TB-LAMP may be used as a replacement test for sputum smear microscopy.
- 6 Testing for isoniazid resistance using FL-LPA or phenotypic DST is advised (See also **Algorithm 1**). A third sample should be collected if neither of the original two samples collected has sufficient volume for both microscopy and Xpert MTB/RIF testing, or according to national guidelines.
- 7 Testing for isoniazid resistance using FL-LPA or phenotypic DST is advised (See also **Algorithm 1**). Patients should be initiated on first-line TB drugs regimen according to national guidelines, unless isoniazid resistance is detected or the patient is at very high risk of MDR-TB. In such case, treat according to national guidelines awaiting the Xpert MTB/RIF result.
- 8 Further investigations for TB may include chest X-ray, additional clinical assessments, monitoring clinical response following treatment with broad-spectrum antimicrobial agents, or culture if available.

3.2.2. Operational procedures for Algorithm 2

Step 1

Evaluate the person for TB, determine HIV status, and assess risk factors for having MDR-TB.

- a. As Xpert MTB/RIF testing becomes available, expand access to include all adults and children being evaluated for TB (i.e., **Algorithm 1**).
- b. PLHIV include persons who are HIV positive, as well as those with unknown HIV status who present with strong clinical suspicion for HIV infection in settings with high prevalence of HIV, or being member of a risk group for HIV.
- c. For all people with unknown HIV status, HIV testing should be performed according to national guidelines.
- d. For PLHIV who have CD4 counts ≤ 100 cells/ μ l or are seriously ill with one or more danger signs, a urine LF-LAM assay may also be used (see **Algorithm 4**).

Step 2

For PLHIV, persons at risk of MDR-TB, and children, collect two or three good quality sputum specimens. Conduct smear microscopy (or TB-LAMP test) on one sample, on site, and transport another sample to the testing laboratory for the Xpert MTB/RIF test.

- a. Because of a potential delay in receiving the Xpert MTB/RIF result, programs may prefer having smear microscopy results from two specimens.
 - i In case that only two specimens are collected, smear microscopy may be done on both specimens if at least one of the two samples has adequate volume for conducting both microscopy and Xpert MTB/RIF; otherwise, the Xpert MTB/RIF test should be given priority on the second sample.

- ii If both samples were used for smear microscopy (or TB-LAMP test), a third sample should be imperatively collected and referred for Xpert MTB/RIF testing.
- iii In some settings, it may be preferable to collect three specimens from the start (two for smear microscopy and one for Xpert MTB/RIF testing).
- b. If one or both samples are positive by smear microscopy or the TB-LAMP test, treat with TB drugs while awaiting the Xpert MTB/RIF test result.
 - i In absence of MDR-TB risk, the patient should be initiated on a regimen with first-line TB drugs according to national guidelines.
 - ii For patients at very high risk of MDR-TB (e.g., household contacts of MDR-TB patients), an MDR-TB regimen should be initiated according to national guidelines.
 - iii On receipt of Xpert MTB/RIF test results, follow **Algorithm 1** for the interpretation.
- c. If both samples are negative by smear microscopy or the TB-LAMP test, use clinical judgement for further evaluation or treatment, while awaiting the Xpert MTB/RIF result.
 - i If Xpert MTB/RIF positive, follow the decision tree for **Algorithm 1**.
 - ii If Xpert MTB/RIF negative (MTB not detected), use clinical judgement and conduct additional testing as described in **Algorithm 1**.

Step 3

For patients not in the priority populations, collect two good quality sputum specimens and conduct smear microscopy or TB-LAMP examinations on both. Follow national guidelines for the detection of MTB based on smear microscopy.

- a. If one or both samples are positive, treat with a regimen of first-line TB drugs according to national guidelines.
 - i If resources allow, collect an additional specimen and refer for microscopy and Xpert MTB/RIF testing, and follow **Algorithm 1** for interpretation and additional testing. One of the already collected specimens may be referred for Xpert MTB/RIF testing if sufficient volume is available.
 - ii If Xpert MTB/RIF testing is not available and if the infrastructure and resources for FL-LPA have been developed, a specimen may be referred for testing with FL-LPA to detect MTB and to assess resistance to isoniazid and rifampicin. Note that FL-LPA is recommended for use with smear-positive sputum samples only. FL-LPA results are interpreted as described in the WHO *Policy Update: use of molecular line probe assay for the detection of resistance to isoniazid and rifampicin*.
- b. If both samples are negative, re-evaluate the patient and conduct additional testing in accordance with national guidelines.
 - i Further investigations for TB may include chest X-ray, Xpert MTB/RIF test, additional clinical assessments, monitoring clinical response following treatment with broad-spectrum antimicrobials (fluoroquinolones should not be used), or culture.
 - ii Consider the possibility of clinically defined TB (i.e. no bacteriological confirmation). Use clinical judgement for treatment decisions.

3.3. Algorithm 3: Testing for second-line drug resistance among rifampicin-resistant TB or MDR-TB patients

3.3.1. Scope and specifications

Algorithm 3 is applicable for further evaluation of patients with RR-TB or MDR-TB. The results of DST for FQs and SLIDs should ideally be known for all RR-TB and MDR-TB patients before starting treatment. However, patients with RR-TB or MDR-TB should be initiated on a second-line regimen, without delay, pending DST for FQs and SLIDs results. See the WHO Guidelines for the programmatic management of drug-resistant tuberculosis, 2016 update for more details on choice of regimen.

Decision tree for **Algorithm 3** targets patients with RR-TB or MDR-TB and outlines the use of SL-LPA as the initial diagnostic test for resistance to FQs and SLIDs for these patients.

- The diagnostic accuracy of SL-LPA is similar when it is performed directly on sputum or from cultured isolates.
- SL-LPA is only recommended for use with sputum specimens or MTB isolates. The laboratory testing of other specimen types should rely on culture and phenotypic DST.
- SL-LPA is suitable for use at the central or national reference laboratory level, and may be used at the regional level if the appropriate infrastructure and human resources are available. Implementation of SL-LPA testing requires a reliable specimen transport system and efficient result reporting procedure.

Note: If SL-LPA is not available, patients should be treated according to national guidelines. Patients may be evaluated for the use of a shorter MDR-TB regimen using criteria such as country drug-resistance patterns and the patient's treatment history. Algorithms that rely on culture and phenotypic DST are described in the WHO Policy framework for *Implementing Tuberculosis Diagnostics*. If done, phenotypic DST should include testing for resistance to the FQs and SLIDs used in the country. If phenotypic DST to second-line drugs is not available in-country, specimens or isolates may be shipped to an external laboratory for testing (e.g. WHO Supranational Reference Laboratory).

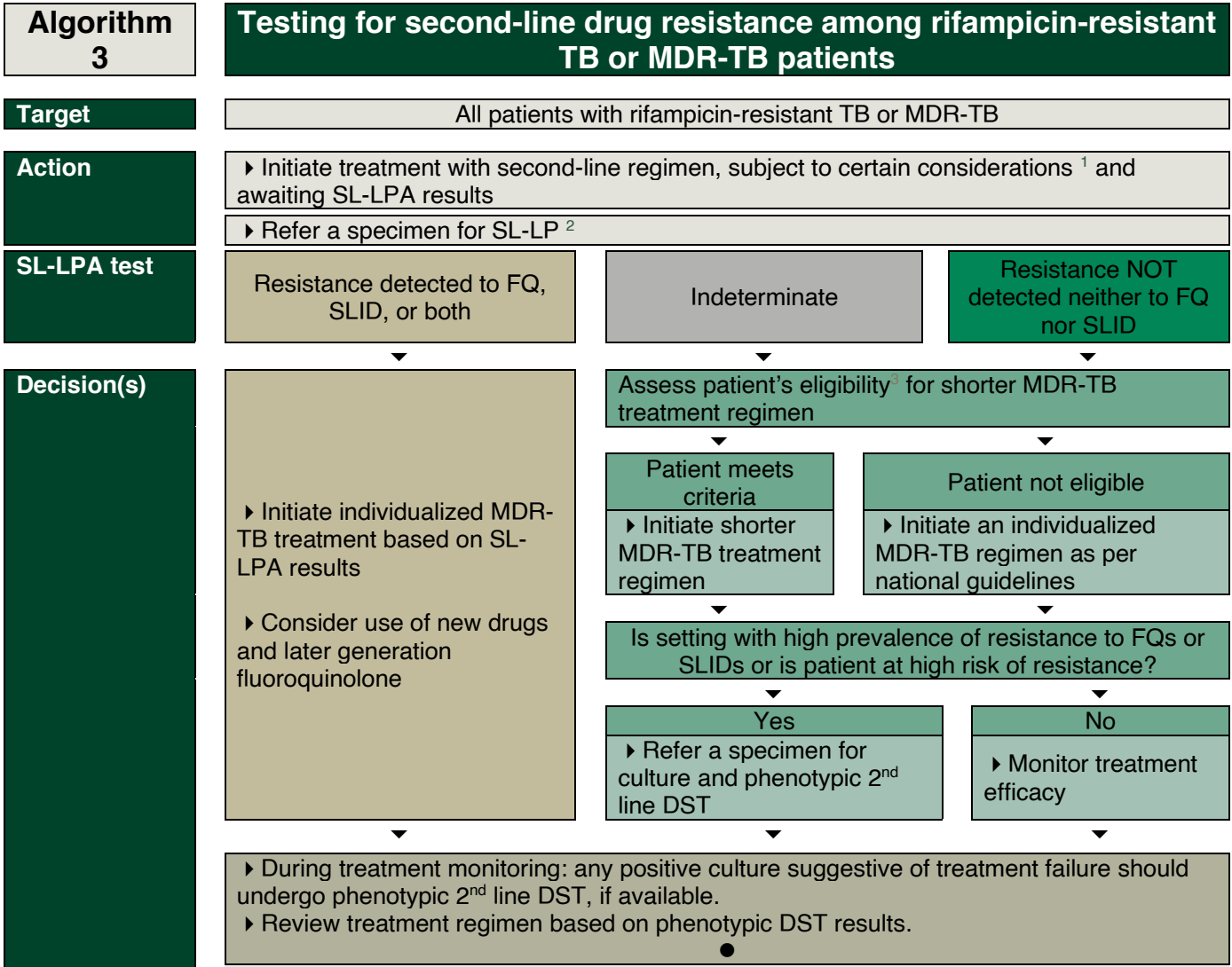

- 1 In patients who are assessed as being at low risk of resistance to FQs and to SLIDs, and meet the eligibility requirements, the shorter MDR-TB regimen may be initiated. In patients at high risk of resistance or in settings with high prevalence of resistance to FQs or SLIDs, selection or design of the treatment regimen to initiate may be guided by SL-LPA, if the results can be obtained rapidly. See WHO Guidelines for the programmatic management of drug-resistant tuberculosis, 2016 update.
- 2 Diagnostic accuracy is similar when SL-LPA is performed directly on sputum or on cultured isolates. SL-LPA can be used on smear-positive or smear-negative specimens although a higher rate of indeterminate results will occur when testing smear-negative specimens. In addition, FL-LPA may help detect isoniazid mutations, which can guide the use of isoniazid (high-dose) and thioamides in a longer regimen. See WHO's guidelines on the use of molecular line probe assays for the detection of resistance to second-line anti-tuberculosis drugs, 2016.
- 3 The shorter MDR-TB regimen may be used in MDR-TB patients, except in the following cases: 1) confirmed resistance or suspected ineffectiveness to one of the shorter MDR-TB regimen drugs (except isoniazid), 2) previous exposure for >one month to one of the second-line drugs included in the shorter MDR-TB regimen, 3) intolerance to one or more drugs in the shorter MDR-TB regimen or increased risk of toxicity, 4) pregnancy, 5) extrapulmonary TB, 6) at least one of the shorter MDR-TB regimen drugs is not available.

3.3.2 Operational procedures for Algorithm 3

Step 1

Transport a sputum specimen or culture isolate to the appropriate laboratory for SL-LPA testing.

Step 2

- If SL-LPA detects a mutation(s) associated with resistance to FQ, SLID, or both, the patient should be initiated on a personalized MDR-TB treatment regimen considering use of new drugs and later generation fluoroquinolones.
- Note that cross-resistance between FQs drugs or between SLIDs drugs is complex and not fully understood; there are limited data on the ability of SL-LPA to assess the cross-resistance.

Step 3

- If SL-LPA is negative for mutations associated with resistance to FQs and to SLIDs, the patient should be assessed for eligibility to the shorter MDR-TB regimen.
 - a. The shorter MDR-TB regimen may be used in MDR-TB patients who do not have any of the following conditions: 1) confirmed resistance to or suspected ineffectiveness of one of the medicines (except isoniazid) composing the shorter MDR-TB regimen, 2) previous exposure for >1 month to a second-line medicine included in the shorter MDR-TB regimen, 3) intolerance to one or more medicines in the shorter MDR-TB regimen or increased risk of toxicity, 4) pregnancy, 5) extrapulmonary disease.

- i Eligible patients should be placed on a shorter MDR-TB regimen according to national guidelines.
 - ii For eligible patients at risk of having FQ-resistant or SLID-resistant TB (e.g., based on the country drug-resistance patterns), a specimen should be referred for culture and phenotypic DST, if such testing capacity is available. At a minimum, the phenotypic DST should include testing for resistance to the FQs and SLIDs used in the country.
 - iii Reliable DST is available for the FQs and SLIDs. Although technically difficult, reliable DST for pyrazinamide is available, and resistance to pyrazinamide at the start of treatment may also be considered a criterion for exclusion to shorter MDR-TB regimen.
 - iv Reliable DST for ethambutol and the other drugs in the regimen (i.e., prothionamide, clofazimine) are not available and WHO does not recommend basing treatment decisions on the DST for these drugs. See WHO frequently asked questions about the implementation of the new WHO recommendation on the use of the shorter MDR-TB regimen under programmatic conditions, Version: 20 December 2016 and WHO Guidelines for the programmatic management of drug-resistant tuberculosis: 2016 update for a detailed discussion.
- b. If the patient is not eligible for the shorter regimen, the patient should be started on an MDR-TB regimen in accordance with national guidelines.
- i In settings with high underlying prevalence of resistance to FQs or SLIDs or for patients considered at high risk of resistance, a specimen should be referred for culture and phenotypic DST, if such testing capacity is available.
 - ii If phenotypic DST to FQs and SLIDs is not available in-country, specimens or isolates may be shipped to an external laboratory for testing (e.g., a WHO Supranational Reference Laboratory).
 - iii At a minimum, the phenotypic DST should include testing for resistance to the FQs and SLIDs used in the country. The regimen should be modified as needed based on the results of the phenotypic DST.

Step 4

- For all patients, treatment monitoring should include the collection of samples for culturing as described in the WHO Guidelines for the programmatic management of drug-resistant tuberculosis, 2016 update.
- Any positive culture suggestive of treatment failure should undergo phenotypic DST, if available.
- At a minimum, the phenotypic DST should include testing for resistance to the FQs and SLIDs used in the country.
- The regimen should be modified as needed based on the results of the DST.

Considerations for the use of SL-LPA

When used to directly test sputum specimens from patients with RR-TB or MDR-TB, SL-LPA detects 86% of FQ resistance and 87% of SLID resistance and rarely gives false positive results (very high specificity for both FQ and SLID resistance), as described in the 2016 WHO policy guidance: *The use of molecular line probe assays for the detection of resistance to second-line anti-tuberculosis drugs*. Therefore, the WHO recommends that treatment decisions be made based on the SL-LPA results with the following considerations:

- a. Despite good specificity and sensitivity of SL-LPA for the detection of FQ resistance (pooled sensitivity of 86% and specificity of 99% compared to phenotypic DST) and SLID resistance (pooled sensitivity of 87% and specificity of 99% compared to phenotypic DST), culture and phenotypic DST is required to completely exclude resistance to the individual drugs in these drug classes as well as to other second-line drugs.
- b. In settings with high probability for resistance to either FQs or SLIDs or both, phenotypic DST may be particularly needed to exclude resistance when the SL-LPA does not detect mutations associated with resistance.
- c. SL-LPA cannot determine resistance to individual drugs in the class of FQs. Resistance conferring mutations detected by SL-LPA is highly correlated with phenotypic resistance to ofloxacin and levofloxacin. However, the correlation of these mutations with phenotypic resistance or clinically significant resistance to moxifloxacin and gatifloxacin is unclear. Therefore, inclusion of moxifloxacin or gatifloxacin in an MDR-TB regimen is best guided by phenotypic DST results.
- d. SL-LPA has high specificity for the detection of resistance conferring mutations in the RRS gene and these mutations are highly correlated with phenotypic resistance to each of the SLIDs (kanamycin, amikacin and capreomycin). However, mutations in the EIS promoter region correlate with phenotypic resistance to kanamycin only. These mutations also confer an increase in the minimum inhibitory concentration (MIC) for amikacin, but the clinical significance of the increase in amikacin MIC is unknown.

3.4 Algorithm 4: Evaluation of TB among PLHIV who are seriously ill or have CD4 accounts ≤ 100 cells/ μ l

3.4.1. Scope and specifications

Algorithm 4 is used for PLHIV being evaluated for pulmonary or extrapulmonary TB, who have a CD4 cell count less than or equal to 100 cells/ μ l or who are seriously ill regardless of CD4 count. This algorithm is based on Annex 15 of the WHO Consolidated guidelines on the use of antiretroviral drugs for treating and preventing HIV infection. Recommendations for a public health approach – Second edition.

- Follow **Algorithm 1** or **Algorithm 2** for all other persons being evaluated for TB; i.e. other than PLHIV who have a CD4 cell count less than or equal to 100 cells/ μ l or who are seriously ill regardless of CD4 count.
- Algorithm 4 may be used for both pulmonary or extra- pulmonary TB.
- The Xpert MTB/RIF test is the preferred initial diagnostic test for **Algorithm 4**.
- The lateral flow urine lipoarabinomannan (urine LF-LAM) assay may also be used to assist in the diagnosis of TB in these individuals; it may be especially useful in persons who cannot produce a good quality sputum specimen or when the Xpert MTB/RIF test is not available.

Testing using the approved rapid methods should be given priority. Smear microscopy and culture may be useful, particularly when the rapid tests do not detect MTB.

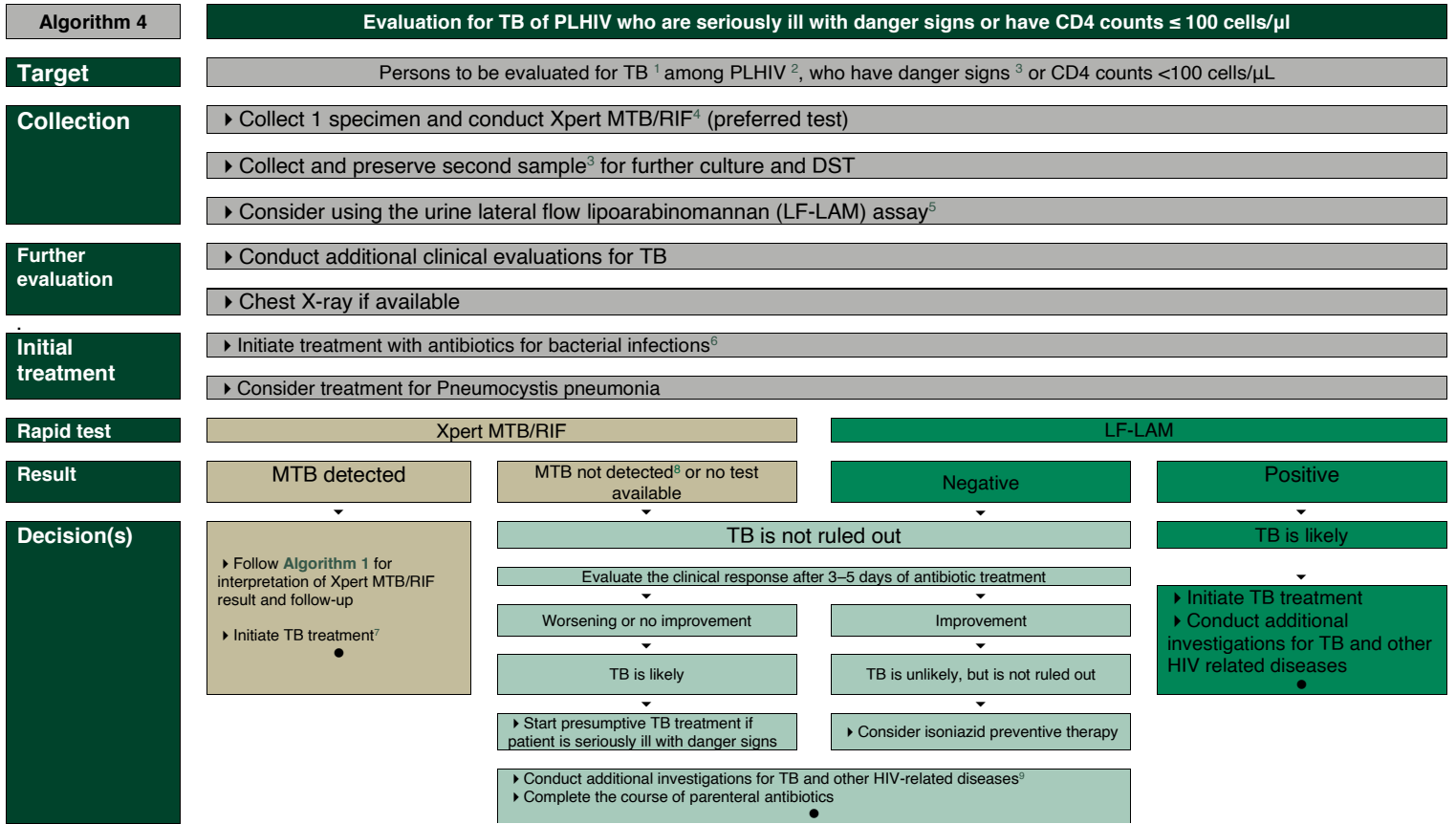

Note: The above diagram is adopted in Kingdom of Saudi Arabia, by modifying some steps while keeping the original information obtained from the reference. TB: Tuberculosis, PLHIV: people living with HIV; MTB: mycobacteria tuberculosis, LF-LAM: Lateral flow urine lipoarabinomannan assay

- 1 Persons to be evaluated for TB include adults and children with signs or symptoms suggestive of TB or with a chest X-ray with abnormalities suggestive of TB. This algorithm may also be followed for the detection of MTB using CSF, lymph node and other tissue specimen from persons being evaluated for extrapulmonary TB.
- 2 PLHIV (People living with HIV/AIDS) include: 1) persons who are HIV positive; 2) persons with unknown HIV status, who present with strong clinical evidence of HIV infection in settings where there is a high prevalence of HIV or are member of a risk group for HIV. For all people with unknown HIV status, HIV testing should be performed according to national guidelines. For all adults living with HIV/AIDS regardless of CD4 cell count or clinical stage, ART should be recommended and initiating cotrimoxazole preventive therapy should be considered.
- 3 Danger signs include any one of the following: respiratory rate >30 per minute; temperature >39 °C; heart rate >120 beats per minute; or inability to walk unaided.
- 4 The Xpert MTB/RIF test is the preferred initial diagnostic test. For persons being evaluated for pulmonary TB, sputum is the preferred specimen.
- 5 The LF-LAM assay may be used to assist in diagnosing active TB in both inpatients and outpatients PLHIV, who are seriously ill with danger signs, regardless of CD4 count. Testing with the LF-LAM assay may be especially useful for patients who are unable to produce a sputum specimen. Whenever possible, a positive LF-LAM should be followed with other tests such as Xpert MTB/RIF. While awaiting results of other tests, clinicians should consider initiating TB treatment immediately based on the positive LF-LAM and their clinical judgment.
- 6 Antibiotics with broad-spectrum antibacterial activity should be used. Do NOT use fluoroquinolones.
- 7 Initiate a treatment with first-line or second-line TB drugs based on the Xpert MTB/RIF result. See **Algorithm 1**.
- 8 If the Xpert MTB/RIF test does not detect MTB, the test can be repeated using a fresh specimen. See Algorithm 1 for a discussion of possible follow-up testing for an Xpert MTB/RIF result of MTB not detected.
- 9 Further investigations for TB may include chest X-ray, additional clinical assessments, a repeat Xpert MTB/RIF using a fresh specimen, or culture. If the patient is being evaluated for extrapulmonary TB, extrapulmonary specimens should be obtained and sent for culture and abdominal ultrasound may be performed.

3.4.2 Operational procedures for Algorithm 4

Step 1

Evaluate the patient for TB, determine HIV status, and assess presence of danger signs for being seriously ill. In PLHIV who are not seriously ill, it may also be necessary to measure CD4 cell counts to assess eligibility for testing with the LF-LAM assay.

- a. Persons to be evaluated for TB include adults and children with signs or symptoms suggestive of pulmonary or extrapulmonary TB or with a chest X-ray with abnormalities suggestive of TB.
- b. PLHIV include persons who are HIV positive or whose HIV status is unknown, but who present with strong clinical evidence of HIV infection in settings where there is a high prevalence of HIV or among members of a risk group for HIV. For all people with unknown HIV status, HIV testing should be performed according to national guidelines.
- c. Seriously ill is defined as a patient presenting with any one of the following danger signs: respiratory rate >30 per minute; temperature >39 °C, heart rate >120 beats per minute; or unable to walk unaided.

Step 2

Collect a specimen and conduct the Xpert MTB/RIF test. Follow **Algorithm 1** for result interpretation and follow-up testing.

- a. For persons being evaluated for pulmonary TB, induced or expectorated sputum (preferred), bronchoalveolar lavage, gastric lavage, and gastric aspirate specimens may be used. Data are limited for the sensitivity of the Xpert MTB/ RIF with other samples such as nasopharyngeal aspirates, string test samples, or stool samples.
- b. For persons being evaluated for extrapulmonary TB, the Xpert MTB/RIF test is recommended for use with CSF, lymph nodes and other tissue samples. However, the test has low sensitivity for pleural fluid specimens and data are limited for its sensitivity with stool, urine or blood specimens.

Step 3

Testing with the LF-LAM assay may be especially useful for patients who are unable to produce a sputum specimen, or in case that Xpert MTB is not available on site.

- a. Collect a urine specimen and conduct the LF-LAM assay.
 - i. If the Xpert MTB test is available on site, the LF-LAM testing should be done in parallel to the Xpert MTB/RIF test.
 - ii. A positive LF-LAM result should be interpreted in the context of clinical judgment, chest X-ray findings (if available), and bacteriological results including Xpert MTB/RIF testing. While awaiting results of other tests, clinicians could consider initiating TB treatment immediately based on the positive result of the LF-LAM test and their clinical judgment.

- iii If the LF-LAM result is negative, re-evaluate the patient and conduct additional testing in accordance with national guidelines. Further investigations for TB may include chest X-ray, repeat Xpert MTB/RIF test, additional clinical assessments, or culture.

Step 4

Conduct additional clinical evaluations for TB such as initiating treatment for bacterial infections using antibiotics with broad-spectrum antibacterial activity (except fluoroquinolones). Consider treatment for *Pneumocystis pneumonia*. Evaluate clinical response after 3–5 days of treatment.

- a. If clinical worsening or no improvement after 3–5 days of treatment, initiate further investigations for TB and other diseases and, if patient is seriously ill with danger signs, start presumptive TB treatment.
- b. If clinical improvement, reassess for TB and other HIV-related diseases.
 - i Consider that clinical improvement may occur if the patient has TB and a bacterial infection, i.e., TB may not be ruled out.
 - ii If there is high clinical suspicion of TB (clinical history and physical exam, history of previous TB that can be reactivated, chest ray suggestive) in the patient, use clinical judgement as to whether to initiate TB treatment.
- c. All patients should complete the course of treatment for bacterial or *Pneumocystis* infections.

Considerations when using the LF-LAM test

- The LF-LAM test should not be used to assist in the diagnosis of TB in populations other than described in Algorithm 4 and should not be used as a screening test for TB.
- LF-LAM is designed for use with urine samples. Other samples (e.g., sputum, serum, CSF or other body fluids) should not be used.
- LF-LAM does not differentiate between the various species of the genus *Mycobacterium*. However, in areas with a high prevalence of TB, the LAM antigen detected in a clinical sample is likely to be attributed to MTB.
- The use of the LF-LAM assay does not eliminate the need for other diagnostic tests for TB such as Xpert MTB/RIF or culture. These tests have better diagnostic accuracy than LF-LAM assay, and provide information on drug susceptibility. Whenever possible, a positive LF-LAM should be followed with other tests such as Xpert MTB/RIF, or bacteriological culture with drug-susceptibility testing.
- Published studies revealed that the LF-LAM test may give a different result than the Xpert MTB/RIF test or culture (e.g., LF-LAM positive, Xpert MTB/RIF MTB not detected). This is probably due to the two tests having different sensitivities and measuring different analytes. Treatment decisions should rely on clinical judgement and all available information.

Reference

GLI model TB diagnostic algorithms Revised June 2018 through the website: http://www.stoptb.org/wg/gli/assets/documents/GLI_algorithms.pdf

4. Tuberculosis Laboratory Diagnostic Methods

4.1. Biosafety in Laboratory diagnosis of tuberculosis

Mycobacterium tuberculosis, the causative agent of TB, is classified as a risk group 3 agent, which calls for a Biosafety Level 3 laboratory (BSL3) for culture and culture based drug susceptibility testing and molecular technique; while other methods such as direct microscopy and molecular techniques require BSL2 (as per Kingdom of Saudi Arabia circular no. 1441-547023).

Access to a safety laboratory should be restricted to staff members and accredited visitors. This chapter describes the most important features of the facility, the procedures, and the personal protective equipment required to ensure biosafety.

Appropriate infection control measures are necessary to enable laboratory staff to work safely with potentially infectious microorganisms. These measures are based on the following four main components:

- Administration (management)
- Environment (engineering)
- Personal protective equipment (PPE)
- Technical expertise and training (good microbiological practices).

4.1.1. Biohazard Warning Sign for laboratory doors



BIOHAZARD

ADMITTANCE TO AUTHORIZED PERSONNEL ONLY

Biosafety Level: _____

Responsible Investigator: _____

In case of emergency call: _____

Daytime phone: _____ Home phone: _____

Authorization for entrance must be obtained from
the Responsible Investigator named above.

4.1.2. General safety rules

As a rule, the following issues should be taken into consideration in BSL3 laboratories:

Ample space should be provided around the equipment for cleaning and maintenance.

Walls, ceilings and floors should be non-absorbent, easy-to-clean, impermeable to liquids and resistant to the chemicals and disinfectants normally used in the laboratory. Floors should be slip resistant.

Openings through these surfaces (e.g. for service pipes) should be sealed to prevent leakage and facilitate decontamination of the room/s using gas.

Bench tops should be impervious to water and resistant to disinfectants, acids, bases, organic solvents and moderate heat.

Lighting should be adequate for all activities. Undesirable reflections and glare should be avoided.

Laboratory furniture should be sturdy.

Open spaces between and under benches, cabinets and equipment should be accessible for cleaning.

Windows should be sealed and break-resistant.

Storage space must be adequate to hold supplies for immediate use and thus prevent clutter on bench tops and in aisles. Additional long-term storage space, conveniently located outside the laboratory working areas, should also be provided for storage of samples, cultures, records and for designated laboratory waste prior to autoclaving.

A hand-washing station with hands-free controls should be provided near the exit door.

To contain unintended release of aerosols, a controlled ventilation system should continuously maintain the negative pressure. A visual monitoring device should be placed at the entrance and in the inside of the laboratory to enable the pressure to be checked.

There should be an alarm to warn personnel when pressure is out of range without causing panic or undesirable reactions.

The building ventilation system should be installed in such a way that air from the containment laboratory can never be recirculated to other sections of the building.

Air from the BSL3 laboratory should be filtered by HEPA filters. When air extracted from the laboratory is discharged to the outside of the building, it must be dispersed away from occupied buildings and air intakes. A heating, ventilation and air-conditioning control system may be installed to prevent positive pressurisation of the laboratory.

The HEPA filters must be installed in a manner that permits gaseous decontamination and testing. The exhausted air from biological safety cabinets, which will have been passed through HEPA filters, should be discharged in a manner not to interfere with the air balance in the laboratory.

Biological safety cabinets should be situated away from walking areas and cross-currents from doors and ventilation systems.

There should be a program in place for the regular testing and validation of biological safety cabinets.

An autoclave for the decontamination of contaminated waste material should be available in the containment laboratory, ideally in the wall. In this way, containers with contaminated waste can be loaded in the BSL3 laboratory via the autoclave procedure, then safely removed in a clean zone outside of the laboratory. In accordance with local regulations in some countries, the autoclave may be connected to the laboratory, located in the same building. In this case infectious waste must be transported in sealed, unbreakable and leak-proof containers in accordance with national or international regulations, as appropriate. These containers should preferably have vents that open when the containers are heated, thereby enabling steam exhaustion outside the containers.

Waste water coming from the sinks installed in BSL3 should be decontaminated in kill tanks. Otherwise, if decontamination facilities are not available, sinks should not be installed.

Safety systems should be implemented to handle the risks of fire and electrical emergencies. An emergency shower and an eyewash facility should also be installed.

Suitably equipped and readily accessible first-aid areas or rooms should be available near the BSL3 laboratory. The personnel of a BSL3 laboratory should ideally have received first-aid training.

A mechanical ventilation system should provide an inward flow of air without recirculation.

There should be a reliable and adequate electricity supply and emergency lighting to permit safe exit. A back-up system is highly important (e.g. a stand-by generator and a UPS to support alarm systems and other essential equipment such as biological safety cabinets, freezers, etc.)

4.2. Quality assurance and quality control

Quality assurance (QA)	A system for continuously improving and monitoring the reliability, efficiency and clinical utilization of laboratory tests. Quality control, quality improvement and method validation are integral components of quality assurance.
Quality assessment (or Quality control)	A process of regular performance checks to ensure that a method is performing as expected. Internal quality assessment (IQA) includes controls tested in parallel with specimens/isolates. This evaluates the precision and accuracy of the test results, the performance of the test reagents, and how well laboratory staff perform when carrying out the test.
External quality assessment (EQA) or proficiency panels	Specimens/isolates received from an independent organization in order to assess the performance of the participating laboratory. Inter-laboratory comparison is an alternative when proficiency panels are not available and includes the exchange of specimens/isolates with other laboratories (usually at least three) that perform the same tests.
Validation	Validation is the ‘confirmation by examination and the provision of objective evidence that the particular requirements for a specific intended use are fulfilled.’ (ISO 17025)
Key indicators	For each test, key indicators should be identified and followed routinely in order to monitor trends (early detection of deviations).

4.3. Smear microscopy

To date, two types of acid-fast stains are used to detect mycobacteria in clinical specimens:

- Carbol-fuchsin staining (Ziehl-Neelsen [ZN] method and its modification performed without heating the dye [Kinyoun cold staining]); and
- Fluorochrome (auramine or auramine-rhodamine) staining.

Smear microscopy is simple, inexpensive and efficient in detecting most infectious cases of pulmonary tuberculosis. However, its performance is highly dependent on its good execution; therefore, ensuring high quality of smear microscopy is crucial in the fight against TB, notably in resource-limited settings.

A major limitation of smear microscopy is its low sensitivity (25–75%) compared to culture and the high number of bacilli required for positivity (in the range of 5×10^3 – 10^4 bacilli per ml). Sensitivity and positive predictive value (PPV) of smear microscopy are influenced by numerous factors such as the prevalence and severity of the disease, the type and quality of specimen, the number of mycobacteria in the sample and the quality of the smear preparation, staining and reading process. Smear microscopy does not enable identification of mycobacterial species, nor does it give an indication of the viability of mycobacteria in the sample. In HIV co-infected TB patients, who may have disseminated paucibacillary disease with fewer AFB, smear microscopy is often negative or may require more scrutiny in screening to identify lower numbers of AFB.

4.3.1. Sample collection

A good specimen should be approximately 3–5 ml volume. Sputum specimens should appear thick and mucoid, or clear with purulent grains. The color varies from opaque white to green. Bloody specimens will appear reddish or brown. Note that clear saliva or nasal discharge is not suitable as TB specimen.

4.3.2. Criteria of acceptability

Upon arrival in the laboratory, the quality of sputum samples should be assessed and reported in the referral form. TB-positive sputa can vary in color and aspect. If the sample is liquid and water-like clear without particles or streaks of mucous material, the poor quality of the sample should be reported on the result form. When possible, encourage the patient/physician to submit a new specimen. However, saliva can yield positive results. All specimens should be processed, except for broken or leaking containers, which should be discarded and another specimen requested. Accept small quantities if the patient has difficulty producing sputum. Blood-streaked sputum is suitable, but pure blood should not be examined.

4.3.3. Microscope Components

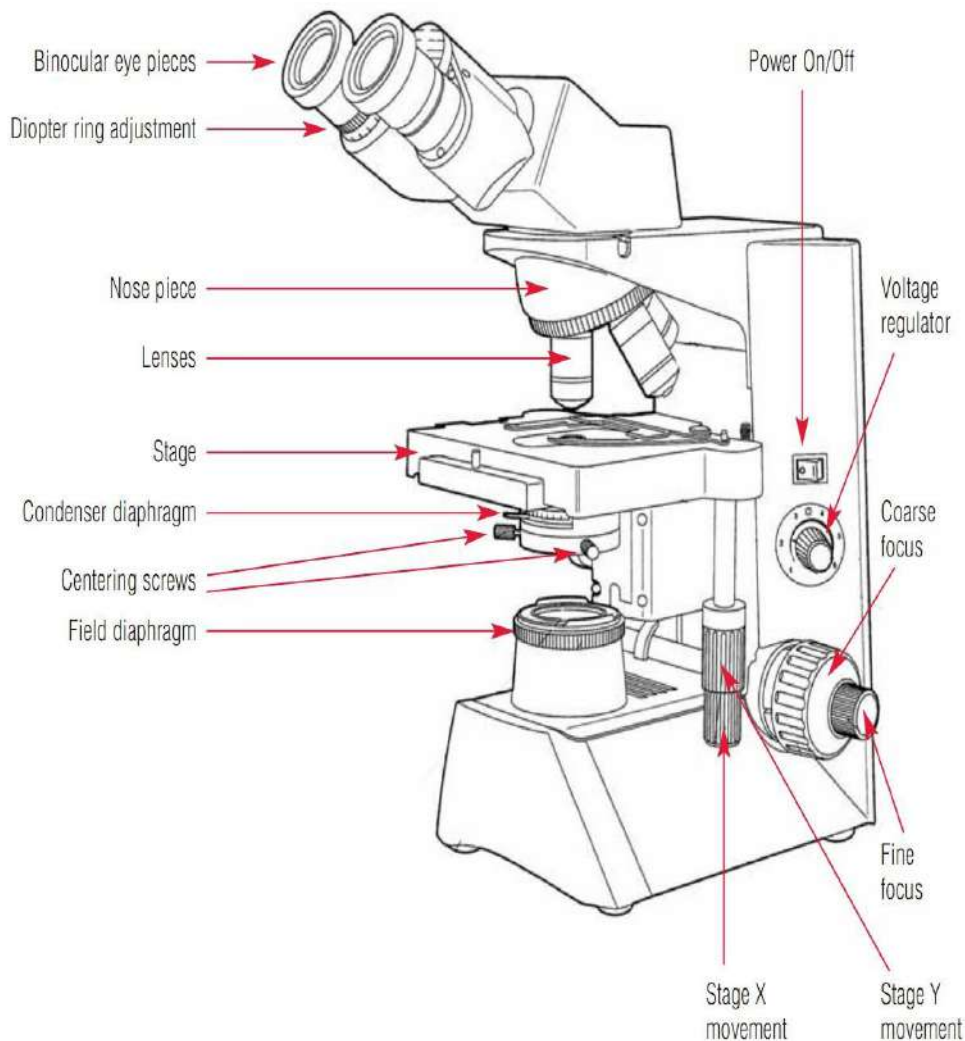

4.3.4. Reporting of Microscopy Smears

IUATLD/WHO scale (1000x field = HPF)	Microscopy System		
	Bright field (1000x magnification: 1 length=2 cm=100 HPF)	Fluorescence (200–250x magnification: 1 length = 30 fields = 300)	Fluorescence (400x magnification: 1 length = 40 fields = 200)
Result			
Negative	Zero AFB/1 length	Zero AFB/1 length	Zero AFB/1 length
Scanty	1–9 AFB/1 length or 100 HPF	1–29 AFB/1 length	1–19 AFB/1 length
1+	10–99 AFB/1 length or 100 HPF	30–299 AFB/1 length	20–199 AFB/1 length
2+	1–10 AFB/1 HPF in at least 50 fields	10–100 AFB/1 field on average	5–50 AFB/1 field on average
3+	>10 AFB/1 HPF in at least 20 fields	>100 AFB/1 field on average	>50 AFB/1 field on average

4.3.5. Common Causes of Error in Smear Microscopy

Error	Cause	Action to be taken
False negative	Smear too thick, detaching during staining	Improve homogenization, reduce the material deposited.
	Smear too thin	Increase the amount or make smear in 1x2 cm area only.
	Poor staining	Check quality control of reagents, prepare new reagents, check dilution.
False positive	Cross-contamination	Avoid contact between slides during staining procedure, do not use staining jars. Clean objective lens after reading each slide. Check water/solutions for environmental contamination.
	Red precipitates	Prepare new solution. Filter before use.

4.4. Culture tests for Mycobacterium tuberculosis complex

The primary advantage of culture tests over sputum microscopy is their higher sensitivity, allowing for the detection of very low numbers of bacilli (approximately 10 bacilli/ml of sputum compared with at least 5000 bacilli/ml of sputum for microscopy). The use of cultures increases the potential of diagnosing TB at early stages of the disease. Culture tests are also used for the detection of treatment failures and for diagnosing

extrapulmonary TB. The use of culture tests increases the number of TB cases diagnosed by 30–50%. Moreover, cultures are used for species identification and drug susceptibility testing (DST).

If not easily accessible, culture tests should at least be performed for:

- Diagnosis of cases with clinical and radiological signs of pulmonary TB where smears are repeatedly negative
- Diagnosis of extrapulmonary TB
- Diagnosis of childhood TB
- Diagnosis of TB among HIV-positive adults and children; and
- Diagnosis and monitoring of MDR- and XDR-TB

Although mainly a pulmonary disease, tuberculosis can affect any organ of the body. The isolation of the etiological agent for effective microbiological diagnosis is dependent on:

- Selection of the correct type of specimen
- The quality of the sample; and
- Adequate use of storage and transportation procedures.

The WHO recommends that all specimen processing procedures are carried out in a BSL2 built and equipped laboratory. The minimum requirements for a BSL2 tuberculosis laboratory are: restricted access to the laboratory, the presence of a fully functional and maintained biological safety cabinet, and an autoclave or other means of decontamination available in the same building.

Identification, sub culturing, and drug susceptibility testing should be performed in a BSL3 containment room with an anteroom and directional airflow from functionally clean to dirty areas, with at least 6 to 12 air exchanges per hour. The containment room may be the blind end of a corridor, or formed by constructing a partition and door so that the laboratory is accessible through an anteroom (e.g. double-door entry) or through the basic BSL2 laboratory. The autoclave should be in the vicinity of the laboratory so that the movement of contaminated materials is minimized. Biological safety cabinets have to be ducted to the outside or vented through a thimble. Air recirculation from biological safety cabinets into the laboratory room and to other areas within the building is not permitted.

As *M. tuberculosis* grows slowly, with a generation time of 18–24 hours (other bacteria reproduce within minutes), usual bacteriology techniques are not applicable to mycobacterial cultures. Moreover, growth requirements are such that *M. tuberculosis* will not grow in primary isolation on simple, chemically-defined media. The only media that enable abundant growth are egg-enriched media containing glycerol and asparagine, agar or liquid media supplemented with serum or bovine albumin. Different media have been developed for *M. tuberculosis* growth and are generally classified into two main groups: solid media (egg- and agar-based) and liquid media. Antibiotics can be added to culture media in order to prevent the growth of non-specific flora; such media are called “selective”.

Both solid and liquid media are suitable for *M. tuberculosis* isolation from biological samples. An advantage of solid over liquid media is that colonies of mixed cultures and contaminants can be observed while liquid media promotes a faster growth of mycobacteria. However, the choice of media depends primarily on the type of specimen. Non-selective media are recommended for use with samples from normally sterile sites (bone marrow, tissue biopsy samples, cerebrospinal fluid and other body fluids etc.), while selective media, which contain antimicrobial agents to prevent bacteria and fungi contamination, are recommended for use with contaminated (or potentially contaminated) specimens (sputum, abscess contents, bronchial washings, gastric lavage fluid, urine, etc.).

The most commonly used non-selective media are:

- egg-based media: Löwenstein-Jensen (LJ) medium and Ogawa medium
- agar-based media: Middlebrook 7H10 and Middlebrook 7H11; and
- liquid media: Middlebrook 7H9 broth.

Commonly used selective media (available in some countries) are:

- egg-based media: Gruft modification of LJ (containing malachite green, penicillin and nalidixic acid as selective agents, and Mycobactosel LJ (containing malachite green, cycloheximide, lincomycin and nalidixic acid as selective agents)
- agar-based media: selective 7H11 (Mitchison's medium), containing carbenicillin, amphotericin B, polymixin B and trimethoprim as selective agents; and
- liquid media: in general, they contain a modified Middlebrook 7H9 broth plus a mixture of antimicrobial agents. Several automated systems have been commercially developed for rapid detection of mycobacteria in liquid medium:
 - ♦ BACTEC μ GIT 960 system (BD [Becton, Dickinson and Company] Diagnostic Systems, Sparks, Maryland)
 - ♦ ESP Culture System II (Trek Diagnostic Systems, Westlake, Ohio)
 - ♦ MB/BacT (BioMérieux, Marcy-l'Étoile, France).

4.4.1. Liquid media

Liquid media offer a considerable time advantage over solid media: 7–14 days in Middlebrook 7H9 liquid medium, compared with 18–28 days in Middlebrook 7H11 agar and 21–42 days in LJ medium. One of the most widely used automated systems for rapid detection of mycobacteria in liquid medium is the BACTEC μ GIT 960 system. The system's culture tubes consist of modified Middlebrook 7H9 broth, a growth supplement, and an antimicrobial agent mixture. A similar principle is used in the ESP Culture System II and the MB/BacT system. In the BACTEC 960 system and ESP Culture System II, *M. tuberculosis* growth is detected by the rate of oxygen consumption within the headspace of the cultures. In the MB/BacT system, a colorimetric sensor detects the production of CO₂ dissolved in the culture medium.

Positive Controls	Result
<i>M. tuberculosis</i> ATCC 25177	Growth on all media
<i>M. kansasii</i> ATCC 12478	Growth on all media
<i>M. scrofulaceum</i> ATCC 19981	Growth on all media
<i>M. fortuitum</i> ATCC 2841	Growth on all media
<i>M. intracellulare</i> ATCC 13950	Growth on all media (not included when testing penicillin- or carbenicillin-containing selective media)
Negative Control	Result
<i>Escherichia coli</i> ATCC 25922	Partial inhibition in non-selective media, total inhibition in selective media

Common contaminants are detailed below:

Non-tuberculous mycobacteria:

- Fast- or slow-growers
- Acid-fast bacilli
- Not usually arranged in cords.

Fungi:

- Usually slow-growers
- Non-acid-fast
- Hyphae are thicker than mycobacteria.

Bacteria:

- Usually non-acid-fast except for some closely related genera (Gordonia, Tsukamurella, Nocardia, Rhodococcus, Dietzia) and Legionella micdadei

Yeast:

- Usually non-acid-fast

Oocystis:

- Usually non-acid-fast except for Cryptosporidium, Isospora, Cyclospora

4.5. Line probe assay for MTB and MDR- and XRD-TB identification

Line probe assay is used in the identification of *Mycobacterium* species and detection of potential multidrug-resistant (MDR) and extensively multidrug-resistant (XDR) tuberculosis from cultures and smear-positive specimens.

The molecular testing is based on DNA strip technology and enables genetic differentiation of species belonging to the genus *Mycobacteria*. The Hain CM test is used to identify common mycobacteria and the AS test to further differentiate additional species. The GenoType MTBC test differentiates between the species of the *M. tuberculosis* complex. The CM, AS and MTBC strips detect and analyze positive mycobacterial cultures and must not be used to detect mycobacteria directly from patient specimen.

The GenoType MTBDRplus test allows for the detection of *M. tuberculosis* complex and, simultaneously, its resistance to rifampicin and/or isoniazid by mutations in the *rpoB* and *katG/inhA* (high/low isoniazid resistance) genes, respectively. The GenoType MTBDRsl simultaneously detects *M. tuberculosis* complex and its resistance to fluoroquinolones (e.g. ofloxacin and moxifloxacin) and/or aminoglycosides/cyclic peptides (injectable antibiotics such as capreomycin, viomycin/kanamycin, amikacin) and/or ethambutol. The MTBDRplus and MTBDRsl are validated for DNA extracted from both positive cultures and smear-positive pulmonary specimens. Note that these tests are licensed for smear-positive sputum only and should not be used to detect mycobacteria directly from smear-negative materials, unless the laboratory independently validates their use. The currently available GenoType MTBDRplus v.2 assay has better sensitivity characteristics. All procedures are identical and are divided into three steps: DNA extraction, a multiplex amplification using biotinylated primers, and reverse hybridization.

4.6. First- and second-line drug susceptibility testing for Mycobacterium tuberculosis complex

Major objectives for drug susceptibility testing (DST) in tuberculosis include:

- i Ensuring effective individual treatment and management of a tuberculosis case,
- ii Enabling anti-TB drug resistance surveillance at the level of a hospital, city, region or country;
- iii Identifying the need for institutional isolation of patients; and
- iv Determining the scope of required investigations in case of institutional or community outbreak.

Because of the worldwide development of drug resistance in tuberculosis, drug susceptibility testing to first-line drugs is required for each confirmed case of tuberculosis (a patient with a positive culture for the *M. tuberculosis* complex or one sputum smear positive for AFB if a culture is not available). Drug resistance rates are higher in re-treatment cases (acquired resistance or secondary resistance) than in new cases (primary resistance); the difference varies according to the country or epidemiological situation. Drug resistance occurring during treatment, designated as 'acquired' or 'secondary resistance', results from the selection and multiplication of resistant mutant isolates that were preexisting in the tubercle bacillus population before therapy. Drug resistance observed before treatment, designated as 'primary resistance', is the consequence of exposure to a drug-resistant source of infection.

4.6.1. General method – DST by culture

Resistance is defined as a decrease in sensitivity to a drug so that the concerned strain is different from wild-type reference strains. In this case, the patient is unlikely to respond clinically to the drug. Susceptibility is defined by a level of sensitivity of a given strain that is comparable to that of wild-type strains, which have never come into contact with the drug. In this case, the patient is likely to clinically respond to the drug.

Susceptibility testing methods may test one index drug by family, e.g. rifampicin susceptibility results cover both rifampicin and rifapentine, prothionamide results cover ethionamide and vice-versa; test each drug individually (rifampicin does not cover rifabutin and streptomycin does not cover amikacin and kanamycin).

First-line drugs include isoniazid (H), rifampicin (R), ethambutol (E), streptomycin (S) (although streptomycin is no more part of most standard treatments), and pyrazinamide (Z), which is usually part of the standard treatment but is not considered a first-line testing drug due to the difficulty to obtain reliable results.

Second-line drugs consists of the drugs used to treat MDR-TB cases, including injectable drugs (kanamycin, capreomycin and amikacin), fluoroquinolones (ofloxacin or levofloxacin, and moxifloxacin), ethionamide or prothionamide, and cycloserine and linezolid. In some cases, imipenem, clofazimine and clarithromycin are used for last-chance treatment of XDRTB cases, i.e. MDR-TB strains with additional resistance to fluoroquinolones and to injectables; however, these drugs are not regularly tested since acquired resistance (resistance occurring during treatment) is unknown. For the new drugs, bedaquiline and delamanid, which became available in 2014, critical breakpoints were proposed by EUCAST/EMA but the methods of testing are still under investigation. In general, second-line DST is less standardized than first-line DST. This is due to insufficient knowledge and drug instability resulting in variation of the active concentration achieved in the media after preparation, besides other factors.

Drug susceptibility testing in liquid media (μ GIT 960)

The Becton Dickinson μ GIT 960 uses 7H9 liquid media, which contains an oxygen-quenched fluorochrome embedded in silicone at the bottom of the tube. During bacterial growth, the free oxygen is utilized and replaced with carbon dioxide. With the depletion of free oxygen, the fluorochrome is no longer inhibited, resulting in fluorescence and identification of bacterial growth, which can be read manually or automatically.

4.6.2. Automated real-time DNA amplification test for rapid and simultaneous detection of TB and rifampicin resistance XPERT® MTB/RIF ASSAY

The Xpert MTB/RIF assay simultaneously detects the presence and rifampicin resistance of *Mycobacterium tuberculosis* in less than two hours. The sensitivity of the Xpert MTB/RIF assay for detecting TB is superior to that of microscopy and comparable to that of solid culture. It has also a high specificity. The biosafety precautions required for Xpert MTB/RIF are similar to those for smear microscopy, which allow the use of the assay outside of conventional laboratories. Training requirements are minimal, enabling the test to be carried out by non-laboratory staff. Several Xpert cartridges for other diseases are available, and all can be used on the same GeneXpert platform as an integrated testing.

Major advantages of the Xpert MTB/RIF assay are:

- Results are available expeditiously,
- Minimal technical training is required to run the test,
- Simultaneous identification of eventual multidrug-resistant TB (MDR TB).

MDR TB is TB that is resistant to both isoniazid (INH) and RIF, two of the most effective TB drugs. RIF resistance is a predictor of MDR TB because resistance to RIF, in most instances, co-exists with resistance to INH.

Timely diagnosis of RIF resistance by Xpert MTB/RIF enables patients to start on effective treatment immediately, instead of waiting for the results from other drug susceptibility testing. By rapidly ruling out TB, in suspected cases, using Xpert MTB/RIF assay unnecessary treatment can be avoided, eventually with the related morbidity (adverse effects) and economic costs due to drug consumption and respiratory isolation in hospitals or other institutions.

4.6.3. Ultra 'MTB detected trace', culture negative

An Ultra result of 'MTB detected trace' indicates that there are very few bacilli in the specimen. The interpretation of such result, combined with a negative culture, must consider patient characteristics, specimen type, and whether the person had been previously treated for TB. Cultures may be falsely negative for a variety of reasons including ongoing treatment for TB or with fluoroquinolones, transport or processing issues that inactivate the tubercle bacilli, cultures lost to contamination, or inadequate testing volume. Finally, the discrepancy may also be due to laboratory or clerical error.

On the other hand, the very small numbers of bacilli in a sample that generates an 'MTB detected trace' result may be due to active TB disease, laboratory cross-contamination, recent exposure to, or infection by, tubercle bacilli (insipient TB), and current or past treatment for TB.

The FIND multicenter study revealed that many of the samples that generated results of 'MTB detected trace' and culture negative were from persons who had completed therapy within the past four to five years; presumably because of the presence of small numbers of non-viable or non-replicating bacilli. Thus, 'MTB detected trace' results must essentially be interpreted in the context of prior treatment.

Note that all initial 'MTB detected traces' results should be followed-up with a second Ultra test on a fresh specimen, which also may contain very few bacilli and may generate a result of 'MTB not detected' as well.

The following specific clinical pictures should be considered:

- 1 For PLHIV and children who are being evaluated for pulmonary TB, or when extrapulmonary specimens (CSF, lymph nodes and tissue specimens) are tested, the benefits of the increased sensitivity for the detection of MTB outweighs the potential harm of decreased specificity.
 - a. 'MTB detected traces' result in one or both samples should be considered as bacteriological confirmation of TB (i.e., true positive results) and used for clinical decisions if the samples were collected from a person who was not receiving treatment with anti-TB drugs or fluoroquinolones.
 - b. Follow-up actions may include the following: re-evaluate the patient for TB, assess the response to therapy (culture results may not be available until six to eight weeks after specimen collection), reassess the possibility of prior or current treatment with anti-TB drugs (including fluoroquinolone use), evaluate the possibility of laboratory or clerical error, and/or repeat culture.
- 2 For adults being evaluated for pulmonary TB who are not at risk of HIV, the balance of the benefit and potential harm varies based on whether the person had been previously treated for TB because of decreased specificity (i.e., false positives)

- a. For persons in whom a history of prior TB treatment can be reliably excluded:
 - i 'MTB detected traces' result in both Ultra tests should be considered as bacteriological confirmation of TB (i.e., true positive results) and used for clinical decisions.
 - ii If the second Ultra test result is 'MTB not detected', the possibility of a false positive results is not excluded, recognizing that such result may also be generated if the second sample contains very few bacilli.
 - Clinical decisions should be based on the second Ultra result ('MTB not detected'), any other available clinical and radiological information, and clinical judgement.
 - Consider the possibility of clinically defined TB (i.e., no bacteriological confirmation).
 - iii Follow-up actions may include: re-evaluate the patient for TB, reassess possibility of prior or current treatment with anti-TB drugs (including fluoroquinolone use), repeat Ultra testing, evaluate the possibility of laboratory or clerical error, and/or repeat culture.
- b. For adults with a history of recent TB treatment:
 - i The possibility of the Ultra 'MTB detected trace' result being false-positive must be considered, as traces may be due to the presence of non-viable bacilli.
 - ii Clinical decisions should be based on any available clinical and radiological information, and clinical judgement. Consider the possibility of TB reactivation, relapse or reinfection.
 - iii Follow-up actions may include re-evaluating the patient for TB, conducting additional testing in accordance with national guidelines, repeating culture, and evaluating the possibility of laboratory or clerical error.

Reference

Handbook on tuberculosis laboratory diagnostic methods in the European Union Updated 2018. Available at: <https://www.ecdc.europa.eu/sites/portal/files/documents/TB-handbook-updated-2018.pdf>

Planning for country transition to Xpert® MTB/RIF Ultra Cartridges. Available at: http://stoptb.org/wg/gli/assets/documents/GLI_ultra.pdf

5. Treatment of Tuberculosis

5.1. Background

National governments are committed to treat TB patients as part of the worldwide strategy against TB, by ensuring uninterrupted supply of good-quality drugs and comprehensive accessibility to standard care for all patients. Therefore, the main objectives of the Saudi NTP are to cure the patients, monitor them for side effects and enhance their compliance with treatment.

5.2. Aims of treatment

The aims of TB treatment are:

- To cure the patient and restore his/her quality of life and productivity.
- To prevent death from active TB.
- To prevent relapse of TB.
- To reduce transmission of pulmonary TB to others.
- To prevent the development and transmission of drug resistance TB.

5.3. Hospitalization

While hospitalization appears to be more efficient strategy to isolate the patient and prevent TB dissemination, it may be inconvenient for the patient. Further, TB patients become less infectious within few days after starting treatment. Therefore, the policy in the kingdom has been changed from hospitalizing all pulmonary smear positive patients, during the first two-month intensive phase of treatment, to only hospitalizing critical cases, MDR and XDR TB, in addition to patients with history of non-compliance. For the other common cases, a patient centered approach is implemented, ensuring strict appliance of standard infection control measures (See [Chapter 17-Patient-centered approach to TB care](#)).

5.4. Health education

Health education for the patients and their relatives about TB constitutes an important element for cure. The topics of health education are mentioned in [Chapter 16](#).

5.5. General procedures that should be followed during treatment

5.5.1. Drug-susceptible pulmonary TB

- In patients with drug-susceptible pulmonary TB, 4-month fluoroquinolone-containing regimens should not be used and the 6-month rifampicin-based regimen 2HRZE/4HR remains the recommended regimen.
- The use of fixed-dose combination tablets is recommended over separate drug formulations in treatment of patients with drug-susceptible TB

- In all patients with drug-susceptible pulmonary TB, the use of thrice-weekly dosing is not recommended in both the intensive and continuation phases of therapy and daily dosing remains the recommended dosing frequency
- In patients who require TB retreatment, the category II regimen should no longer be prescribed, and drug susceptibility testing should be conducted to inform the choice of treatment regimen.

5.5.2. PLHIV, ART & TB treatment

- Antiretroviral therapy (ART) should be started in all TB patients living with HIV regardless of their CD4 cell count. TB Treatment should be initiated first, followed by ART as soon as possible within the first 8 weeks of treatment (Strong recommendation, high certainty in the evidence).
- HIV-positive patients with profound immunosuppression (e.g. CD4 cell counts less than 50 cells/mm³) should receive ART within the first 2 weeks of initiating TB treatment.
- In PLHIV with drug-susceptible pulmonary TB and receiving ART during TB treatment, a 6-month standard treatment regimen is recommended over an extended treatment for 8 months or more.

5.5.3. Extrapulmonary TB

- In patients with tuberculous meningitis, an initial adjuvant corticosteroid therapy with dexamethasone or prednisolone tapered over 6-8 weeks should be used
- In patients with tuberculous pericarditis, an initial adjuvant corticosteroid therapy may be used.

5.5.4. Health education & adherence

- Health education and counselling on the disease and treatment adherence should be provided to patients on TB treatment
- A package of treatment adherence interventions may be offered to patients on TB treatment in conjunction with the selection of a suitable treatment administration
- One or more of the following treatment adherence interventions (may be offered to patients on TB treatment or to health-care providers):
 - a. tracers and/or digital medication
 - b. material support to patient
 - c. psychological support to patient
 - d. staff education
- The following treatment administration options may be offered to patients on TB treatment:
 - a. Community- or home-based DOT is recommended over health facility-based DOT or unsupervised treatment.
 - b. DOT administered by trained lay providers or health-care workers is recommended over DOT administered by family members or unsupervised treatment

- c. Video observed treatment (VOT) may replace DOT when the video communication technology is available, and it can be appropriately organized and operated by health-care providers and patients).

5.6. Factors to be considered in deciding to initiate empirical treatment

Without definitive diagnosis of TB, TB treatment may be initiated empirically by considering a set of patient-related, clinical and paraclinical factors, as well as public health concerns (**Figure 1**).

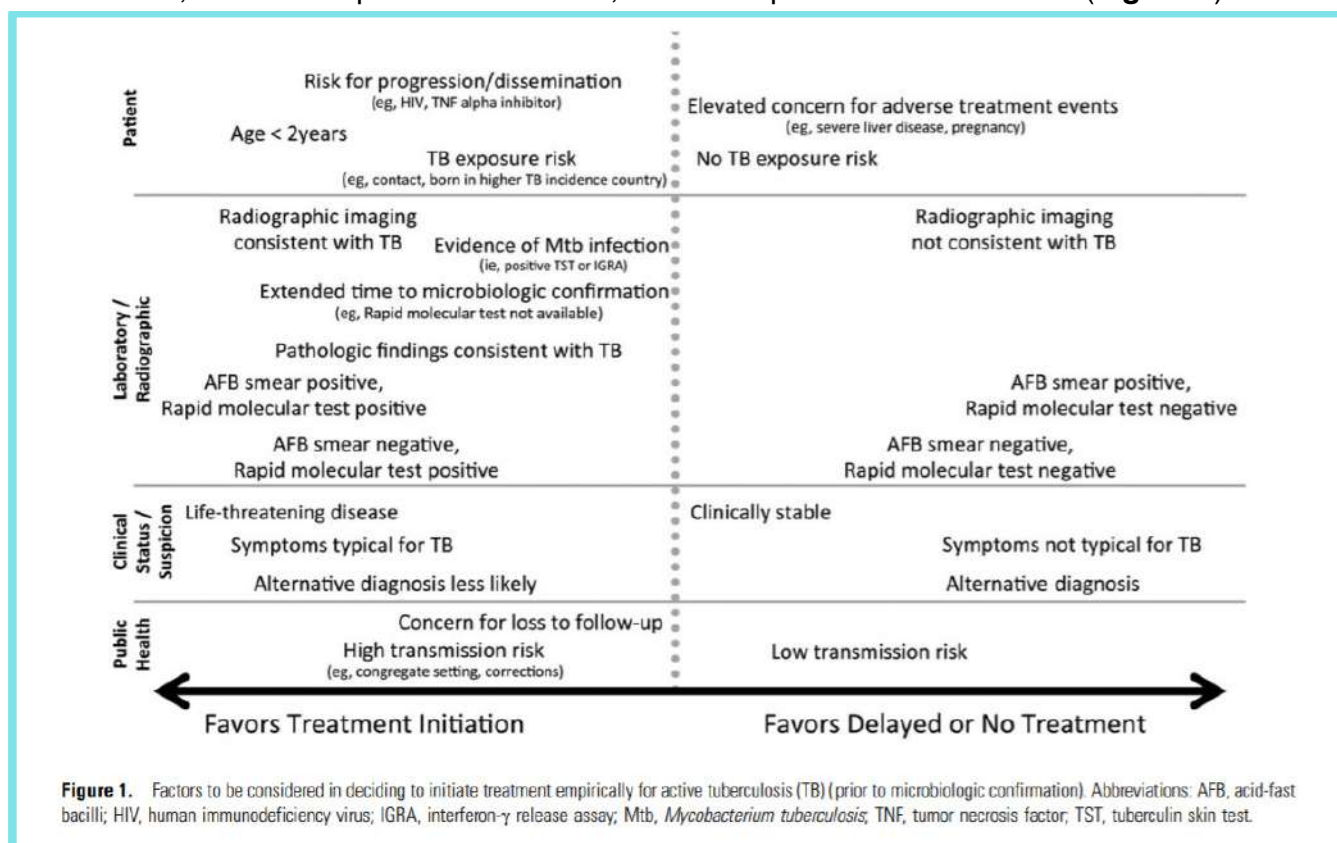

5.7. Summary of changes in the new guidelines 2017 and policy recommendations on treatment of drug-susceptible TB

Duration of rifampicin reduced in new TB patients

- New patients with pulmonary TB should receive a regimen containing 6 months of rifampicin: 2HRZE/4HR
- The 2HRZE/6HE treatment regimen should be phased out

Use of shortened fluoroquinolone-containing regimens revised

- In patients with drug-susceptible pulmonary TB, 4-month fluoroquinolone-containing regimens should not be used, and the 6-month rifampicin-based regimen 2HRZE/4HR remains the recommended regimen.
- The use of FDC tablets is recommended over separate drug formulations in the treatment of patients with drug-susceptible TB.

Dosing frequency of TB treatment in new TB patients

- Wherever feasible, the optimal dosing frequency for new patients with pulmonary TB is daily throughout the course of therapy.
- In all patients with drug-susceptible pulmonary TB, the use of thrice-weekly dosing is **NOT** recommended in both the intensive and continuation phases of treatment, and daily dosing remains the recommended dosing frequency.

Dosing frequency of TB treatment in PLHIV

- TB patients with known positive HIV status and TB patients living in HIV-prevalent settings should receive at least 6 months of rifampicin-containing treatment regimen.
- The optimal dosing frequency is daily, during both the intensive and continuation phases.

Duration of TB treatment for TB patients living with HIV

- It is recommended that TB patients who are living with HIV receive at least the same duration of TB treatment as HIV-negative TB patients.
- In patients with drug-susceptible pulmonary TB who are living with HIV and receiving ATR during TB treatment, a 6-months standard treatment regimen is recommended over an extended treatment for 8 months or longer.

Initial regimen in countries with high levels of isoniazid resistance

- In populations with known or suspected high levels of isoniazid resistance, new TB patients may receive HRE as therapy in the continuation phase, as an acceptable alternative to HR.

Treatment extension in new pulmonary TB patients

- In new pulmonary TB patients treated with rifampicin-containing regimen throughout treatment, if a positive sputum smear is found at completion of the intensive phase, the extension of the intensive phase is not recommended.

The use of steroids in the treatment regimen of tuberculous meningitis and tuberculous pericarditis

- In patients with tuberculous meningitis, an initial adjuvant corticosteroid therapy with dexamethasone or prednisolone, tapered over 6-8 weeks, should be used.
- In patients with tuberculous pericarditis, an initial adjuvant corticosteroid therapy may be used.

Treatment of previously treated TB patients

- Specimens for culture and drug-susceptibility testing should be obtained from all previously treated TB patients at or before the start of treatment. Drug-susceptibility testing should be performed for at least isoniazid and rifampicin.
- In settings where rapid molecular-based DST is available, the results should guide the choice of regimen.

- In settings where rapid molecular-based DST is not routinely available to guide the management of individual patients, empirical MDR regimen should be started in TB patients who failed treatment and other patient groups with high likelihood of MDRTB.
- In patients who require TB retreatment, the category II regimen should no longer be prescribed, and DST should be conducted to inform the choice of treatment regimen.
- In settings where DST results are not routinely available to guide the management of individual patients, the empirical regimens will continue throughout the course of treatment.
- National TB control programs should obtain and use their country-specific drug resistance data on failure, relapse and loss to follow-up of patient groups to determine the levels of MDR-TB.
- Health education about the disease and counselling on treatment adherence should be provided to patients on TB treatment.
- A package of treatment adherence interventions may be offered to patients on TB treatment in conjunction with the selection of a suitable treatment administration option.
- One or more of the following treatment adherence interventions (complementary and not mutually exclusive) may be offered to patients on TB treatment or to health-care providers:
 - a. Tracer or digital medication monitor
 - b. Material support to patient
 - c. Psychological support to patient
 - d. Staff education

The following treatment administration options may be offered to patients on TB treatment:

- a. Community or home-based DOT is recommended over health facility-based DOT or unsupervised treatment.
- b. DOT administered by trained lay providers or health care workers is recommended over DOT administered by family members or unsupervised treatment.
- c. Video observed treatment (VOT) can replace DOT when the video communication technology is available, and it can be appropriately organized and operated by health care providers and patients.

5.8. Treatment of TB in specific situations

5.8.1. Treatment of pregnant and breast-feeding woman

- A pregnancy should systematically be sought among women in childbearing age before starting anti-tuberculosis treatment.
- Most of anti-tuberculosis drugs are safe for use in pregnancy except for streptomycin, which is ototoxic to the fetus and can be replaced by ethambutol.
- It is important to advise pregnant woman that successful TB treatment outcome is important for successful pregnancy outcome.
- For breastfeeding women, it is essential to complete the course of first-line anti-TB drugs, as this is the best way to prevent transmission of tubercle bacilli to the infant, and breastfeeding should be continued.

- After active TB is ruled out in the infant, the latter should be given a 6-month regimen of isoniazid followed by BCG vaccination.
- Pyridoxine supplementation is recommended for all pregnant and breast-feeding women taking isoniazid in a dose of 10 mg daily.

5.8.2. Contraceptive pills and anti-TB drugs

- Rifampicin induces metabolic pathways of other drugs, thereby reducing their plasma concentration and therapeutic effect. When rifampicin is discontinued, its metabolism-inducing effect resolves within two weeks approximately, then doses of other drugs should be reduced.
- Rifampicin interacts with oral contraceptive pills, with a risk of decreasing their efficacy. In this case, the patient is advised to change the contraception method or to use higher-dose estrogen pills (50mcg or more), on her physician's advice.

5.8.3. Treatment of patients with liver disorders

- In absence of clinical evidence of chronic liver disease, patients with the following conditions can receive the usual standard chemotherapy regimens: hepatitis virus carriage, past history of viral hepatitis, excessive alcohol consumption.
- In patients with established chronic liver disease, treatment regimen should not contain more than two hepatotoxic drugs (see possible regimens below).
- Clinical judgment is necessary in patients with acute viral hepatitis, and in some cases, it is possible to defer tuberculosis treatment until the acute hepatitis has resolved.
- Expert consultation is advisable in patients with advanced unstable liver diseases, and clinical monitoring is essential during the whole period of treatment.
- Possible regimens that can be prescribed in patients with established chronic liver disease include:

Two hepatotoxic drugs (rather than the three in the standard regimen):

- 9-month regimen of isoniazid and rifampicin, plus ethambutol (unless or until resistance to isoniazid is documented);
- 2-month regimen of isoniazid, rifampicin, streptomycin and ethambutol, followed by 6 months of isoniazid and rifampicin;
- 6 to 9-month regimen of rifampicin, pyrazinamide and ethambutol.

One hepatotoxic drug:

- 2-month regimen of isoniazid, ethambutol and streptomycin, followed by 10-month regimen of isoniazid and ethambutol.

No hepatotoxic drugs:

- 18 to 24-month regimen of streptomycin, ethambutol and a fluoroquinolone.

5.8.4. Treatment of patients with renal failure

- Isoniazid and rifampicin are eliminated by biliary excretion; therefore, no change in dosing is necessary for these two drugs. However, there is significant renal excretion for ethambutol and pyrazinamide metabolites.
- It is safe to use these drugs in the usual dosage for patients with mild-moderate renal failure, and the recommended regimen is 2HRZE/6HR.
- However, in patients with severe renal failure, ethambutol and pyrazinamide doses should be adjusted, and a 3-time per week administration is recommended using the doses: pyrazinamide (25 mg/kg) and ethambutol (15 mg/kg).
- While receiving isoniazid, patients with severe renal insufficiency or failure should also be given pyridoxine in order to prevent peripheral neuropathy.
- Given its nephrotoxicity, streptomycin has to be avoided in patients with renal failure. However, if streptomycin must be used, the dosage should be calculated as 15 mg/kg 2 or 3 times weekly, with a maximum 1g per dose. Serum level of streptomycin should be monitored during the whole period of treatment and the dose has to be adjusted according to creatinine clearance.

5.9. Essential first-line drugs in treatment of tuberculosis

5.9.1. Isoniazid

Isoniazid is the most popular anti-TB drug, being highly bactericidal, cheap, and easily administered. Additionally, isoniazid is rapidly absorbed by the gastrointestinal tract, reaches a high serum level in two hours approximately, and spreads in all body cavities at a similar concentration to that in the blood.

Dosage and administration

Isoniazid is taken orally and may be administered intramuscularly or intravenously to critical cases.

For adult daily regimen, isoniazid is given at the dose of 5mg/kg (4-6mg/kg) body weight with a maximal dose of 300 mg daily.

Contraindications

Known hypersensitivity and active unstable hepatic disease with jaundice.

Adverse effects

Isoniazid is generally well tolerated at the recommended doses. The main adverse reactions are: hepatitis and elevated liver enzymes, neurological manifestations (e.g. numbness, paresthesia and confusion), systematic or cutaneous hypersensitivity reactions, sleepiness and lethargy.

Drug interactions

Isoniazid inhibits the metabolism of certain drugs such as diazepam, carbamazepine, phenytoin, warfarin, theophylline and acetaminophen, which may require dose reduction as per the clinical data and drug properties.

Over dosage

Nausea, vomiting, dizziness, blurred vision and slurring of speech occur within 30 minutes to 3 hours of over dosage. High doses of pyridoxine must be administered to prevent seizures.

Precautions

- The drug should be protected from light.
- Pyridoxine could be administered to prevent from peripheral neuritis.

5.9.2. Rifampicin

Rifampicin is a bactericidal drug that has a potent sterilizing effect against tubercle bacilli at intracellular and extracellular locations. It is easily administered, fully absorbed from the gastrointestinal tract, and reaches a high serum level in two hours. Rifampicin penetrates weakly in non-inflamed tissues is weak, but reaches inflamed tissues in concentration similar to that in the blood. Resistance to rifampicin is readily developed; therefore, it is recommended to systematically administer the drug in combination with other effective antimycobacterial drugs.

Dosage and administration

Rifampicin should preferably be taken at least 30 minutes before meal, since food digestion reduces its absorption.

For adults, the recommended dose is 10 mg/kg (8-12mg/kg) daily or three times per week, with a maximum 600mg /dose.

Contraindications

Known hypersensitivity and unstable hepatic disease.

Adverse reactions

The main adverse reaction is hepatitis with elevated liver enzymes. Other serious adverse reactions that were reported include thrombocytopenia, purpura, shock and renal failure. Skin rash and gastrointestinal disturbance may occur as well. If adverse reactions occur, the drug should be stopped.

Precautions

- The patient has to be informed that treatment may cause reddish coloration of body fluids, including urine.
- Clinical monitoring should be performed during treatment in patients with pre-existing liver disease.

- Given the risk of postnatal hemorrhage, vitamin K should be administered at birth to infants born for mothers taking rifampicin.
- The drug should be protected from light.

Drug interactions

- Rifampicin induces hepatic enzymes and may increase the dosage requirements of drugs metabolized in the liver, especially contraceptive pills, warfarin, acetaminophen, aluminum salts, carbamazepine, ketoconazole, oral hypoglycemic agents, phenytoin, theophylline and valproate.
- Rifampicin interacts with antiretroviral drugs used in HIV treatment, which may result in ineffectiveness of both ART and anti-TB treatment and increased risk of drug toxicity.

5.9.3. Pyrazinamide

Pyrazinamide has a weak bactericidal effect against mycobacteria but a potent sterilizing activity especially in the intracellular environment and acute inflammation areas. It is administered orally and fully absorbed from the intestine, reaching a high level in the blood within two hours following administration, and penetrates all tissues in adequate concentration.

Dosage and administration

Daily regimes: 25 mg/kg (20-30 mg/kg)

Three times a week: 35 mg/kg (30-40 mg/kg/dose)

Adverse reactions

The main adverse reactions of pyrazinamide include hepatitis with elevated liver enzymes, in addition to arthralgia and elevated uric acid. However, these adverse reactions do not necessitate withdrawal of the drug and can be treated with aspirin.

Contraindications

- Known hypersensitivity
- Active unstable liver disease
- Porphyria

Precautions

- Clinical monitoring in patients with diabetes, gout and liver co-morbidities may be important.
- Protect from light.

5.9.4. Ethambutol

Ethambutol is a bacteriostatic drug. It is administered orally and fully absorbed from the intestine, reaching a high concentration in blood within two hours from administration; however, its tissue penetration is very low, even in case of inflammation.

Dosage and administration

Daily regimen: 15 mg/kg (15-20 mg/kg) daily.

Three times a week regimen: 30 mg/kg (25-35 mg/kg/dose).

Adverse reactions

The main adverse reaction of ethambutol is the dose-dependent optic neuritis, which can cause impairment of visual acuity and color vision, notably red and green colors. Such visual adverse effects generally occur with doses higher than 16 mg/kg. Ethambutol is not recommended for children because onset of vision impairment may be unnoticed.

Precautions

- Advise the patient to read daily and to undergo fundus examination as soon as a reduction of vision acuity is noticed.
- Renal functions should be assessed before treatment, when possible.



5.10. Symptom-based approach to managing anti-TB drugs side effects

Side effect (symptom)	Drug(s) probably responsible	Management
<i>Major</i>		<i>Stop responsible drug(s) and refer to clinician urgently</i>
Skin rash with or without itching	Streptomycin, isoniazid, rifampicin, pyrazinamide	Stop anti-TB drugs
Deafness (no wax on otoscopy)	Streptomycin	Stop streptomycin
Dizziness (vertigo and nystagmus)	Streptomycin	Stop streptomycin
Jaundice (other causes excluded), hepatitis	Isoniazid, pyrazinamide, rifampicin	Stop anti-TB drugs
Confusion (suspect drug-induced acute liver failure if there is jaundice)	Most anti-TB drugs	Stop anti-TB drugs
Visual impairment (other causes excluded)	Ethambutol	Stop ethambutol
Shock, purpura, acute renal failure	Rifampicin	Stop rifampicin
Decreased urine output	Streptomycin	Stop streptomycin
<i>Minor</i>		<i>Continue anti-TB drugs, check drug doses</i>
Anorexia, nausea, abdominal pain	Pyrazinamide, rifampicin, isoniazid	Give drugs with small meals or just before bedtime, and advise patient to swallow pills slowly with small sips of water. If symptoms persist or worsen, or are complicated by pernicious vomiting or any sign of bleeding, consider the side-effect to be major and refer to clinician urgently.
Joint pains	Pyrazinamide	Aspirin or non-steroidal anti-inflammatory drug, or paracetamol
Burning, numbness or tingling sensation in the hands or feet	Isoniazid	Pyridoxine 50–75 mg daily.
Drowsiness	Isoniazid	Reassure and give drugs before bedtime.
Orange/red urine	Rifampicin	Reassure. Patients should be told when starting treatment that this may happen and is normal.
Flu syndrome (fever, chills, malaise, headache, bone pain)	Intermittent dosing of rifampicin	Change from intermittent to daily rifampicin administration.

5.11 Moderate/severe hypersensitivity (immune) drug reactions

- Hypersensitivity drug reaction is presented by hives (raised itchy rash) with or without fever.
- All anti-TB drugs could cause this form of adverse reaction.

5.11.1 Management of moderate/severe hypersensitivity reactions

In children

- Discontinue all drugs.
- Rule out a viral infection.
- If a viral infection is present, restart all of the TB medications (no re-challenge is required).
- If a viral infection is ruled out, follow drug re-challenge guidelines outlined in the table below, doses must be adjusted for age and weight.

In adults

- Discontinue all drugs until the reaction resolves

- Identify the causative drug by re-challenging each drug every four days according to the table below.

Drug re-challenge protocol		
Drug	Drug Challenge Doses	
	Day 1	Day 2
Isoniazid	50mg	300mg
Rifampin	75mg	300mg
Pyrazinamide	250mg	1.0gm
Ethambutol	100mg	500mg
Streptomycin	125mg	500mg

5.1.1.2 Re-challenge guidelines

- If the initial reaction was mild or moderate, start re-challenge with INH 50mg on day 1.
- If the initial reaction was severe, start re-challenge with 1/10 day of 1 dose listed above (e.g. INH 5mg instead of 50 mg).
- After day 1 dose, if no reaction occurs, increase INH to the calculated dose for age and weight on day 2.
- If no reaction occurs after day 2 dose, continue INH with recommended dose for age and weight.
- On day 3, reintroduce other drugs, one by one, in the order and doses specified in the table above, by respecting a 4-day interval between two consecutive drug reintroductions.
- If the day 2 dose is less than the normally recommended dose based on patient's weight, increase to the appropriate dose on day 3.
 - Example: for ethambutol dosing in a 70kg person, day 1=100mg, day 2=500mg, and day 3=1000mg
- If a reaction occurs during drug re-challenge and the causative drug cannot be discontinued, drug desensitization will be necessary.

5.1.1.3 Drug desensitization

- Desensitization should be considered in patients who develop severe reactions, and should be carried out under strict monitoring.
- The patient candidate for desensitization should be receiving at least 2 TB medications, other than the one causing hypersensitivity, before undergoing drug desensitization.
- Three desensitization protocols have been utilized.

General guidelines

- Initiate the day 1 dose as indicated in the table above.
- If a reaction occurs following day 1 dose of drug re-challenge, start desensitization with 1/10 of the day 1 dose.

- Subsequent doses are doubled and administered twice daily until reaching the recommended daily dose.
- Once being reached, the recommended daily dose should be administered twice daily over 3 days, followed by once daily dosing (e.g. INH 150mg bid x 3 days, then 300mg/day).
- If a reaction develops during desensitization, decrease the dose to the highest previous dose that did not cause a reaction, then re-increase the doses with smaller increments.
- In case the drug evoking reaction has been identified and the patient cannot tolerate the required dose, it is better to refer to a higher health care level.

5.12 Drug interaction

Streptomycin should not be used with other ototoxic or nephrotoxic drugs. These include other aminoglycoside antibiotics, amphotericin B, cephalosporin, ethacrynic acid, cyclosporine, cisplatin, furosemide and vancomycin.

Reference

Guidelines for treatment of drug-susceptible tuberculosis and patient care, 2017 update ISBN 978-92-4-155000-0

Guidelines for treatment of drug-susceptible tuberculosis and patient care (2017 update) (https://www.who.int/tb/publications/2017/dstb_guidance_2017/en/, accessed 12 January 2019)

Guidelines for treatment of tuberculosis, fourth edition. Geneva: World Health Organization; 2010 (<http://www.who.int/tb/publications/2010/9789241547833/en/>, accessed 12 January 2019)

Nahid P, Dorman SE, Alipanah N, Barry PM, Brozek JL, Cattamanchi A, et al. Official American Thoracic Society/Centers for Disease Control and Prevention/Infectious Diseases Society of America Clinical Practice Guidelines. Treatment of drug-susceptible tuberculosis. *Clin Infect Dis*. 2016;63(7):e147-95.

WHO policy on collaborative TB/HIV activities. Guidelines for national programmes and other stakeholders 2012. (Document WHO/HTM/TB/2012.1) Geneva: World Health Organization; 2012 (http://www.who.int/tb/publications/2012/tb_hiv_policy_9789241503006/en/, accessed 12 January 2019).

Saukkonen JJ et al. An official ATS statement: hepatotoxicity of antituberculosis therapy. *American Journal of Respiratory and Critical Care Medicine*, 2006, 174:935–952.

ATS/CDC/IDSA Clinical Practice Guidelines for Drug-Susceptible TB • CID 2016:63 (1 October)

6. Monitoring response to treatment

6.1 Background

Response to TB treatment should be monitored in all patients to assess treatment efficacy and detect any secondary resistance. According to the Standard 10 of the ISTC stipulates that “response to treatment in patients with pulmonary tuberculosis (including those with tuberculosis diagnosed by a rapid molecular test) should be monitored by follow-up sputum smear microscopy at the time of completion of the initial phase of treatment (two months). If the sputum smear is positive at completion of the initial phase, sputum microscopy should be performed again at 3 months and, if positive, drug sensitivity testing should be performed. In patients with extrapulmonary tuberculosis and in children, the response to treatment is best assessed clinically”

Medication supervision and patient monitoring are two separate topics. Patient monitoring is compulsory to evaluate the response of the disease to treatment and to identify adverse reactions to drugs, while treatment supervision is to ensure patient’s adherence to treatment. To judge about response to treatment of pulmonary tuberculosis, the most rapid and cost-effective method is sputum smear microscopy.

All patients, their treatment supporters and health workers should be instructed to report the persistence or reappearance of symptoms of TB including weight loss, symptoms of adverse drug reactions, or treatment interruptions. Patient weight should be monitored each month, and drug dosages should be adjusted if weight changes.

A written record of treatment and initial and follow up smears and cultures should be kept. Standard 13 of the ISTC states “An accessible, systematically maintained record of all medications given, bacteriologic response, outcomes, and adverse reactions should be maintained for all patients”.

6.2 Assessing treatment response in newly diagnosed or previously treated pulmonary tuberculosis patients

Both in newly diagnosed and previously treated patients for pulmonary TB, response to regimens containing first-line drugs should be monitored by sputum smear microscopy, in addition to culture and DST (ISTB 10). Sputum should be collected at the end of the intensive treatment phase (second month for new and third month for retreatment). “A positive sputum smear at the end of the initial phase of treatment should trigger an assessment of the patient’s adherence and a careful clinical re-evaluation” (**Standard 10** of the ISTC).

Sputum samples should also be collected from patients with smear negative pulmonary tuberculosis, as sputum may convert from negative to positive, indicating poor response to therapy, poor compliance to therapy or error at the time of diagnosis. If sputum smear was found to be negative at the end of the intensive phase, no further sputum monitoring is required, and the patient should be monitored clinically.

If sputum smear is positive at 3-4 months of therapy, another sample should be collected for culture and drug susceptibility testing (DST), including molecular testing, to assess susceptibility to therapy.

A positive sputum smear at the end of the intensive phase may be secondary to any of the following factors:

Drug-related

- 1 Dosage of anti-TB drugs is below the recommended range.
- 2 The initial phase of therapy is poorly supervised and patient adherence is poor.
- 3 Poor quality of anti-TB drugs.

Bacteriology-related

- 1 Non-viable bacteria remain visible by microscopy.
- 2 Drug-resistant *M. tuberculosis* that is not responding to first-line treatment.

Host-related

- 1 Slow regression of the disease because of extensive cavitation and heavy initial bacillary load.
- 2 Presence of co-morbid conditions that interfere either with adherence or with response, such as HIV infection or other forms of immunosuppression and diabetes.

Therefore, it is highly recommended to regularly review and supervise the patients, in order to detect and manage any poor compliance, treatment intolerance or side effects, in a timely manner. Keeping updated treatment card is essential to facilitate monitoring and evaluating the case on a regular basis.

If sputum smear remains positive by the end of the intensive phase of treatment (second or third month), another sample should be collected after one month (third/fourth month).

If sputum smear remains positive by the end of the third/fourth months, sputum samples should be collected for culture and DST to early detect drug resistance and adapt the treatment accordingly.

For initially smear positive patients, sputum smear should also be collected at the end of the fourth/fifth months, as well as by the end of the continuation phase. If any specimen is found to be positive, the treatment response is declared as failure.

6.3. Assessing treatment response in extrapulmonary TB patients

To assess response to treatment for extrapulmonary TB cases, improvement and resolution of initial symptoms and signs are important. Monitoring patient weight is an essential indicator for response to treatment. Chest radiography is needed prior treatment initiation, to rule out pulmonary TB.

6.4. Recording the standardized treatment outcome

On regular basis, and at the end of treatment course, the district coordinator should record the treatment outcome and update the electronic surveillance system (HESN).

6.5. Cohort analysis of treatment outcomes

A cohort is a group of patients diagnosed and registered for treatment during a specific time period (usually

one quarter of a year). New patients with smear positive pulmonary TB must be evaluated as a separate cohort, as their outcome constitutes a major indicator of program performance. Outcomes in other patients (retreatment, pulmonary smear-negative, extra pulmonary) are analysed in other cohorts.

Cohort analysis should be performed on a quarterly and annual basis, at both the district and national levels, and appropriate action must be taken to overcome problems and to improve performance.

6.6. Management of treatment interruption

A patient who misses an arranged appointment to receive treatment must be contacted within a day following the missed appointment, if during the intensive phase, and within a week, if during the continuation phase. Interrupting patients must be traced using personal data recorded at the start of treatment. It is also important to investigate reasons for missing appointments and provide needed support to encourage compliance.

In case of 2-month interruption, the patient should be traced and repeat investigations, including smear and susceptibility testing, should be performed. In case of re-registering a TB patient due to interruption in the district register, a note that the patient has interrupted treatment must be recorded in front of his previous TB code.

6.7. Treatment in specific situations

6.7.1. Pregnant women and children of smear-positive pulmonary TB mothers:

- Rifampicin interacts with the oral contraceptive pills and reduces their efficacy. Therefore, it would be opportune to change the contraception method or to consult the physician regarding use of higher dose estrogen-containing oral pills (50mcg or more).
- A pregnancy should systematically be sought among women in childbearing age, before starting anti-tuberculosis treatment.
- Most of anti-tuberculosis drugs are safe for use in pregnancy except for streptomycin, which is ototoxic to the fetus and can be replaced by ethambutol.
- Infants born to mothers with open tuberculosis should receive isoniazid prophylaxis for three months or until the mother's smear becomes negative; then Mantoux test should be performed. If Mantoux test result is negative, preventive chemotherapy of infant should be continued three months, followed by BCG vaccination. If Mantoux test result is positive, treatment of the infant should be extended for six months.

6.7.2. Patients with liver disorders

- In absence of clinical evidence of chronic liver disease, patients with the following conditions can receive the usual standard chemotherapy regimens: hepatitis virus carriage, past history of viral hepatitis, excessive alcohol consumption.

- Patients with established chronic liver disease should be treated with one of the following regimens, 2SHER/6HR or 2SRE/10HE, as these drugs are eliminated by the kidney; whereas pyrazinamide should not be administered for those patients.
- Clinical judgment is necessary in patients with acute viral hepatitis, and in some cases, it is possible to defer tuberculosis treatment until the acute hepatitis has resolved. In other cases, 3SE regimen may be applied safely until hepatitis has resolved; then the patient can receive a continuation phase of 6HR.

6.7.3. Patients with renal failure

The recommended regimen in case of renal failure is (2HRZ/6HR), as these drugs are almost entirely eliminated by the biliary excretion or metabolized into non-toxic compounds. It is safe to use these drugs in the usual dosage for patients with renal failure. In patients with severe renal failure, pyridoxine should be used to prevent peripheral neuropathy. Streptomycin and ethambutol, which are eliminated by renal excretion, should be used with caution and at low dosages.

6.7.4. Management of adverse sensitivity drug reactions

- In case of adverse reactions, all anti-TB drugs should be stopped until the reaction is resolved. Subsequently, drugs should be reintroduced one by one, in a gradually increasing dose until reaching the required dosage. If no reaction occurs, for any dosage, the drug is continued and the next drug is reintroduced following the same procedure. It is recommended to start with isoniazid as it is the least likely to induce drug reaction.
- If the drug responsible for the adverse reaction is identified and the patient cannot tolerate the required dose, it is better to refer to a higher health care level.

7. Tuberculosis in Children

7.1. Background

- The diagnosis of TB in children relies on careful and thorough assessment of all the evidences derived from a careful history, clinical examination and relevant investigations.
- Bacteriological confirmation of TB in children is not always feasible, it should be sought whenever possible, e.g. by Xpert MTB/Rif or Xpert Ultra or culture for children with suspected pulmonary TB who are old enough to produce a sputum sample.
- Treatment trial with anti-TB medications as a diagnostic method for TB is not recommended in children.
- Decision to treat a child should be made cautiously; once such a decision is made, the child should be treated with a full course of therapy.

The recommended approach for the diagnosis of TB in children should include:

- 1 Careful history, including history of contact with a TB patient.
- 2 Symptoms consistent with TB.
- 3 Clinical examination, including growth assessment.
- 4 Tuberculin skin testing (TST) or IGRA.
- 5 Bacteriological confirmation with use of Xpert MTB/Rif or Xpert Ultra, whenever possible.
- 6 Investigation relevant for suspected TB.

7.2. Key features suggestive of TB in children

The presence of three or more of the following criteria should strongly suggest TB in children:

- Chronic symptoms suggestive of TB
- Physical signs highly suggestive of TB
- A positive TST or IGRA
- Chest X-ray findings suggestive of TB

7.3. Recommended approach to diagnose TB in children

7.3.1. Careful history taking

History should search for contact with a TB case, especially close contact with smear-positive pulmonary TB. Source cases that are sputum smear-negative but culture-positive are also infectious, but to a lesser extent.

The following points should be considered:

- All children aged 0–4 years and symptomatic children aged 5 years, who have been in close contact with a bacteriologically confirmed pulmonary TB case, must be screened for TB.

- Diagnosis of TB in any child aged below 15 years should trigger investigations to identify the source case, usually an adult with bacteriologically confirmed pulmonary TB, especially in the household or school.
- All contacts of an infectious child should be identified and screened. Children should be regarded as infectious if they have sputum smear-positive pulmonary TB or cavitory TB on CXR. The younger the child, the less likely sputum smear is positive. However, adolescents can develop cavitory TB, which is an “adult like” form, and can be more easily confirmed bacteriologically.

7.3.2. Symptoms

The most common symptoms of TB in children are:

- Chronic, unexplained cough, lasting for more than 2 weeks.
- Fever $>38^{\circ}\text{C}$ for 14 days or more, with exclusion of other causes such as pneumonia or viral infections.
- Weight loss or failure to thrive.

7.3.3. Clinical examination (including growth assessment)

There are no specific features on clinical examination in children with pulmonary TB, compared to adults. Some signs, although uncommon, are highly suggestive of extrapulmonary TB, such as gibbus and non-painful enlarged cervical lymphadenopathy with fistula formation.

Extrapulmonary TB should systematically be ruled out in the following conditions

- Meningitis not responding to antibiotic treatment, with subacute onset or high intracranial pressure.
- Pleural effusion.
- Pericardial effusion.
- Distended abdomen with ascites.
- Non-painful enlarged lymph nodes without fistula formation.
- Non-painful enlarged joint.
- Signs of tuberculin hypersensitivity (e.g. phlyctenular conjunctivitis, erythema nodosum).
- Documented weight loss or failure to thrive.

7.3.4. Tuberculin skin test (TST)

- TST can be used in diagnosing TB in children with signs and symptoms of TB, in combination with other diagnostic tests.
- A TST result >5 mm induration diameter in high-risk children (HIV-infected children and severely malnourished children) should be regarded as positive.
- In all other children (whether they have received BCG vaccination or not), TST is considered positive if induration diameter >10 mm.

Value of the test

- The TST can be used to screen children exposed to TB, such as household contact with TB; although children can still receive chemoprophylaxis.
- TST may lead false-positive false-negative results.
- A negative TST never rules out TB.
- In some TST-negative children, it is useful to repeat TST once their nutritional status has improved or their severe illness (including TB) has resolved, as they may become positive after 2–3 months on treatment.

7.3.5. Bacteriological confirmation whenever possible

- It is highly advisable to confirm diagnosis of TB in a child using whatever specimens and laboratory facilities available.
- Appropriate specimens (sputum, gastric aspirates, biopsy or fine-needle aspiration) should be obtained for Xpert MTB/Rif or Xpert Ultra, culture or histopathological examination.
- Bacteriological confirmation is especially important for children who have:
 - ♦ Suspected drug-resistant TB
 - ♦ HIV infection
 - ♦ Complicated or severe cases of disease
 - ♦ An uncertain diagnosis.
- Common techniques for obtaining samples for bacteriological tests include the following; Expectoration in children who are able to produce a specimen, Gastric aspiration using a nasogastric feeding tube or Sputum induction.

7.3.6. Investigations relevant to suspected pulmonary and extrapulmonary TB in children

Suspected pulmonary TB

- Chest X-ray imaging is useful in the diagnosis of TB in children. In majority cases, children with pulmonary TB have chest X-ray changes suggestive of TB, and the most common finding is persistent lung opacification with enlarged hilar or subcarinal lymph glands.
- A miliary pattern in chest X-ray in non-HIV children is highly suggestive of TB.
- Children with persistent opacification, which does not improve after a course of antibiotics, should be investigated for TB.
- Adolescent patients with TB have chest X-ray changes similar to those of adult patients, including large pleural effusions and apical infiltrates with cavity formation being the most common findings.
- Adolescents may also develop primary disease with hilar adenopathy and lung collapse images on chest X-ray.

Suspected extrapulmonary TB

- The table below shows the investigations usually used to diagnose common forms of extrapulmonary TB. In most of these cases, TB will be suspected from the clinical picture and confirmed by histology or other special investigations.

Site	Practical approach to diagnosis
Peripheral lymph nodes (especially cervical)	Lymph node biopsy or fine needle aspiration
Miliary TB (e.g. disseminated)	Chest X-ray and lumbar puncture (to test for meningitis)
Pleural effusion (older children and adolescents)	Chest X-ray, pleural tap for biochemical analysis (protein and glucose concentrations), cell count and culture
Abdominal TB (e.g. peritoneal)	Abdominal ultrasound and ascetic tap
Osteoarticular	X-ray, joint tap or synovial biopsy
Pericardial TB	Ultrasound and pericardial tap

HIV testing

HIV counselling and testing is indicated for all age TB patients as part of their routine management.

7.4. Treatment of TB in children

Based on the WHO revision of TB treatment in children, the following rules are adopted by the Saudi NTP:

- The recommended dosages of anti-TB drugs for the treatment of tuberculosis in children are:
 - ♦ Isoniazid (H) – 10 mg/kg (range 7–15 mg/kg); maximum dose 300 mg/day
 - ♦ Rifampicin (R) – 15 mg/kg (range 10–20 mg/kg); maximum dose 600 mg/day
 - ♦ Pyrazinamide (Z) – 35 mg/kg (30–40 mg/kg)
 - ♦ Ethambutol (E) – 20 mg/kg (15–25 mg/kg)
- Children with tuberculosis who are HIV-negative can be treated with the following regimen (2HRZ/4HR).
- Children with extensive pulmonary or severe extrapulmonary TB forms should be treated with the following regimen (2HRZE/4HR).
- In HIV-positive children with tuberculosis, initiation of anti-TB treatment is a priority. The same daily 6-month regimen as HIV-negative children can be prescribed, with preference to extend rifampicin use for the whole period of treatment. No intermittent regimens (e.g. thrice-weekly doses) should be used.
- Infants (age 0–3 months) with tuberculosis should be promptly treated with the standard treatment regimens, as described above, considering dose adjustment with respect of age-related risk of

toxicity. Adjustment of doses should be undertaken by a clinician who is experienced in managing pediatric tuberculosis.

- Streptomycin should not be used as part of first-line treatment regimens for children with tuberculosis.
- Children with tuberculous meningitis or osteoarticular tuberculosis should be treated with the following regimen (2HRZE/10HR). It is important to treat tuberculous meningitis in young children as early as possible, especially in children who have a history of contact with an adult having infectious TB.
- The upper end of the recommended dosage range should be considered in case of TB meningitis, given the uncertain penetration of antituberculosis drugs into the central nervous system.
- Miliary or hematogenous disseminated TB has a high risk (60–70%) of meningeal involvement and should therefore be managed similarly to TB meningitis. For this reason, it is recommended that all children with miliary TB (or suspected for having miliary TB) should undergo a lumbar puncture to test for the presence of meningitis.
- Children with TB meningitis or miliary TB should be hospitalized, at least for the first 2 months, preferably.
- Corticosteroids may be used in complicated forms of TB, e.g. TB meningitis, airway obstruction by TB lymph glands, and pericardial TB. In advanced TB meningitis, corticosteroids have been shown to improve survival and decrease morbidity, and thus are recommended in all cases of TB meningitis. The most frequently used corticosteroid is prednisone, at 2 mg/kg daily dosing, to be increased up to 4 mg/kg daily in severely ill children with a maximum dosage of 60 mg/day for 4 weeks. The dose should then be gradually tapered over 1–2 weeks before discontinuation.
- Mycobacterial culture and drug susceptibility testing should be performed for all re-treatment cases.

7.5. Ensuring adherence

Children, their parents and other family members, and other caregivers should be educated about TB and the importance of completing the treatment. Support to child's parents and immediate family members is vital to ensure satisfactory treatment outcome. A health-care worker may observe or carry out treatment administration, but if such arrangement is inconvenient for the family, a trained family member (preferably someone other than the child's parent or immediate family) can undertake this task. Children with severe forms of TB should be hospitalized for the better management, where possible. Conditions that necessitate hospitalization include:

- a. TB meningitis and miliary TB, preferably for the first 2 months, at least.
- b. Respiratory distress.
- c. Spinal TB.
- d. Severe adverse events of treatment, such as clinical signs of hepatotoxicity (e.g. jaundice).
- e. In case of difficulty to ensure good adherence and treatment outcome in outpatient, some children may require hospitalization for social or logistic reasons.

7.6. Follow-up

Ideally, each child should be assessed at least at the following intervals:

- weeks after treatment initiation.
- At the end of the intensive phase.
- Every 2 months until treatment completion.

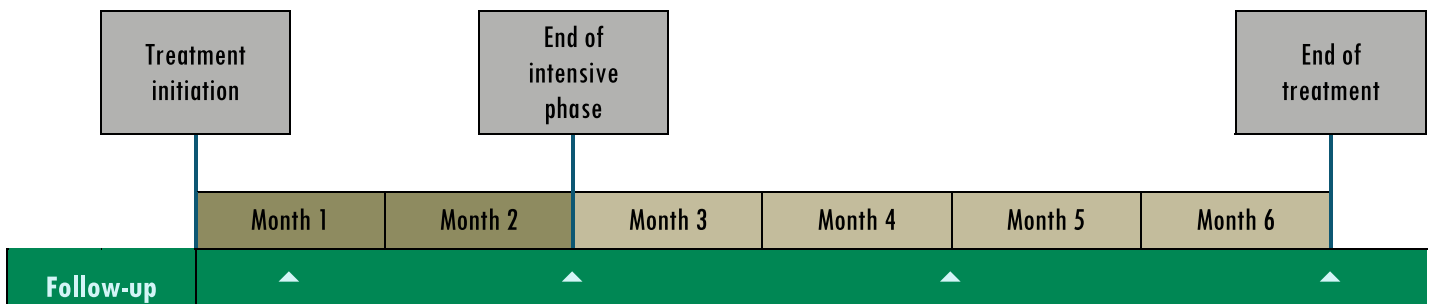

As a minimum, each follow-up assessment should cover the following dimensions:

- Symptoms' progression.
- Adherence to treatment.
- Screening for any adverse events.
- Weight measurement.
- Eventual dose adjustments of medications in case of weight gain.
- Review of patient's treatment card to assess adherence.
- A follow-up sputum sample for smear microscopy at 2 months after treatment initiation should be obtained for any child who was smear-positive at diagnosis.
- Follow-up CXRs are not routinely required in children, particularly as many children will have a slow radiological response to treatment.
- A child who is not responding to anti-TB treatment should be referred for further assessment and management.
- In some cases, a transient clinical deterioration (known as paradoxical reaction) may occur after starting anti-TB therapy, which is due to restored capacity to mount an inflammatory immune response. This can mimic disease progression, associating fever and increased size of lymph nodes or tuberculomas. In these cases, anti-TB treatment should be continued and adjuvant corticosteroids might be useful.

7.7. Adverse events

- Adverse events caused by anti-TB drugs are much less common in children than in adults, and the most important one is hepatotoxicity, which can be caused by isoniazid, rifampicin or pyrazinamide.

- Serum liver enzyme levels should not be monitored routinely, as asymptomatic mild elevation of serum liver enzymes (less than five times the normal values without any clinical sign) is not an indication to stop the treatment.
- The occurrence of liver tenderness, hepatomegaly or jaundice should lead to investigate serum liver enzyme levels and immediately stop all potentially hepatotoxic drugs.
- Patients should be screened for other causes of hepatitis, and no attempt should be made to reintroduce these drugs until liver functions have normalized.
- An expert (experienced in managing drug-induced hepatotoxicity) should be involved in further management of such cases.
- If TB treatment should not be interrupted, e.g. in case of severe forms of TB, non-hepatotoxic anti-TB drugs (e.g. ethambutol, an aminoglycoside and a fluoroquinolone) should be used.
- Supplemental pyridoxine (5–10 mg/day) is recommended in:
 - ♦ Malnourished children.
 - ♦ HIV-infected children.
 - ♦ Breastfeeding infants.
 - ♦ Pregnant adolescents.

8. Tuberculosis & HIV

8.1. Background

Infection with HIV leads to destruction of the immune system cells, making infected person more vulnerable to microorganisms and more prone to develop severe and fatal infections. Acquired immunodeficiency syndrome (AIDS), which is the severe stage of HIV infection, is characterized by the development of opportunistic infections. In absence of treatment, the progression from HIV infection to the first AIDS manifestations may take several years.

In 2017, approximately 120 patients diagnosed with tuberculosis were found to have HIV coinfection, in Saudi Arabia, with an incidence rate of 0.37 (0.31-0.44) cases per 100,000 population.

8.2. Interaction between tuberculosis and HIV

8.2.1. The effects of HIV infection on TB epidemiology, morbidity and management

HIV infection is the strongest known risk factor for the progression of TB infection to active disease and increases the risk of latent TB reactivation by 12 to 20 times. Further, HIV seroprevalence is nearly 4-6 folds higher among TB patients than in the general population. It has also been observed that the incidence of TB increased starting from mid-eighties, in countries where HIV infection prevailed.

PLHIV who are contaminated with *M. tuberculosis* are more likely to present with extrapulmonary or sputum smear-negative forms of TB, especially as immunosuppression advances. This may result in misdiagnosis or delayed diagnosis and, consequently, higher morbidity and mortality.

HIV co-infection increases TB morbidity by two major mechanisms including activation of latent tuberculosis and rapid progression of recently acquired TB infection to clinical tuberculosis.

HIV status of TB patients is a pivotal criterion for TB treatment choice, as HIV-positive status imposes daily dosing regimens during intensive-phase of anti-TB treatment and conditions the use of rifampicin in patients on ART.

8.2.2. The effects of TB on HIV

TB may be the first manifestation of HIV infection; therefore, TB care services play a crucial in HIV prevention, care and treatment.

TB infection and disease leads to activation of the immune system, and proliferation of CD4 lymphocytes and macrophages. This proliferation prompts the HIV replication, resulting in more profound immune suppression and acceleration of progression to AIDS. Consequently, TB infection among PLHIV is associated with high morbidity and significantly reduced survival expectancy.

8.3. Objectives of the NTP regarding PLHIV

HIV represents a real challenge to health care systems in general, and to the NTP in particular, in that it increases the number of TB cases and accelerates dissemination of tuberculosis bacilli in the community. Thus, the broad objectives of tuberculosis control in PLHIV consist of early detection and effective treatment of the largest possible number of TB patients. Achieving such goal will reduce the probability of TB transmission among general public.

These objectives are planned using a strategy that aims at decreasing the burden of TB among HIV patients, which is called the 3Is strategy: *Intensified* case finding of TB cases among HIV patients, provision of *Isoniazid* preventive chemotherapy and *Infection* control of tuberculosis.

In terms of TB/HIV programs collaboration, periodic (quarterly) interaction is undertaken to exchange summary reports from registers on patient enrolment and retention and treatment outcomes (using cohort analysis of groups of all patients starting treatment). These reports should be analyzed, preferably in conjunction with supportive supervision or quarterly review meetings with national AIDS program, and then discussed at the district and national levels for further aggregation, analysis, dissemination and management of the program. The variables available in the registration system will be used in measuring TB/HIV collaborative activities. For example, documenting TB treatment and the start date (month and year) of isoniazid preventive therapy (IPT) and recording TB status as “assessed during the previous visit by national AIDS program”. Similarly, TB registration system has a specific column for HIV testing and another for recording the provision of cotrimoxazole preventive therapy (CPT) and ART. These variables are routinely included in the quarterly summary reports of both programs – and this allows assessment of TB/HIV collaborative activities.

Regular situational analyses should be carried out at the regional program level including the total population of the region, number of administrative units (regions, provinces, districts and sub-districts), number of health facilities, number of staff and the percentage of their time devoted to TB/HIV activities in these facilities, burden of HIV in the region or district, DOTS coverage for TB/HIV.

The policy on collaborative TB/HIV activities contains the following 14 key components:

- Explicit recognition of the potential impact of TB morbidity and mortality in PLHIV.
- Inclusion of NTP representatives in the planning process of the national AIDS program, and vice versa.
- Surveillance of HIV prevalence among TB patients as per international recommendations.
- Advocacy Communication and Social Mobilization (ACSM) strategy for HIV to include accurate information about TB, and vice versa.
- Training staff working on HIV to include accurate information about TB, and vice versa.
- Regular, intensified TB case-finding recommended for all PLHIV.
- ART provided for all eligible HIV-positive TB patients, in accordance with national protocols.
- HIV-positive TB patients to have full access to the continuum of care for PLHIV.

- CPT for all HIV-positive TB patients and all PLHIV in accordance with international guidelines.
- Access to TB investigation and treatment to be part of a basic package of care for PLHIV.
- Treatment of latent TB infection to be offered to all PLHIV in accordance with international guidelines.
- Establishment of a national TB and HIV coordinating body, technical advisory committee or task force.
- HIV testing and counselling routinely offered to all patients in whom TB has been diagnosed.
- Infection control policy and monitoring system.

8.4. Diagnosis of tuberculosis among HIV positive individuals

As tuberculosis among HIV-positive individuals is mostly extrapulmonary or pulmonary smear-negative and may present itself in atypical picture, it could be misdiagnosed or delayed in diagnosis. In this case, X-ray and reliable information may help in clinical suspicion and initiate further advanced testing. The two following flowcharts present the diagnostic algorithms for TB in ambulatory and seriously ill HIV-positive patients, respectively (**Flowchart 8.1 & 8.2**).

Flow chart 8.1. Diagnosis of TB among ambulatory HIV patients

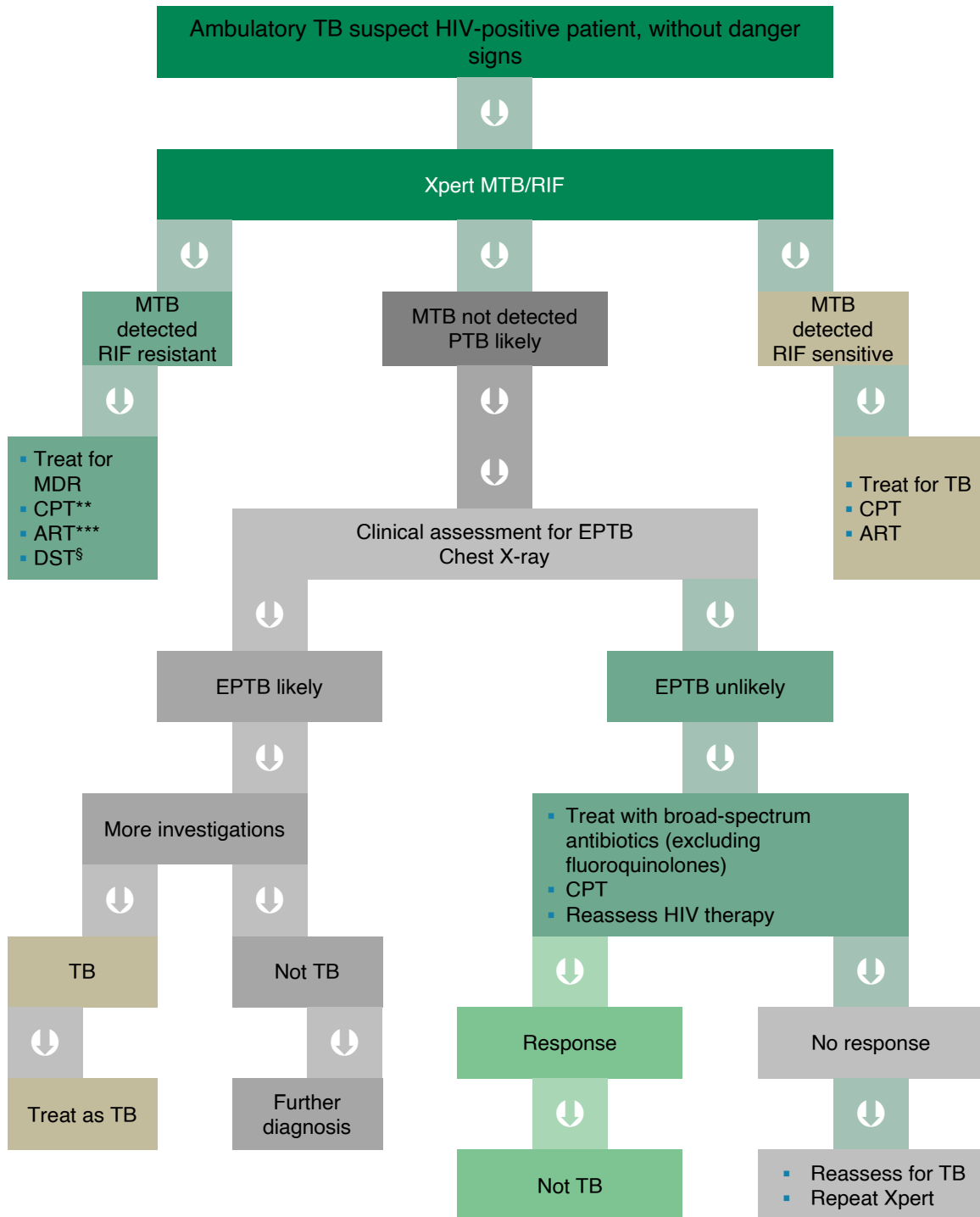

* The danger signs include any one of the following: respiratory rate >30/minute, fever >39 °C, pulse rate >120/min and unable to walk unaided.

** CPT= cotrimoxazole therapy; *** ART= anti-retroviral therapy.

PTB: Pulmonary tuberculosis; EPTB: extrapulmonary tuberculosis; § DST: Drug susceptibility testing

Flow chart 8.2. Management of TB suspect among seriously ill HIV-positive patients

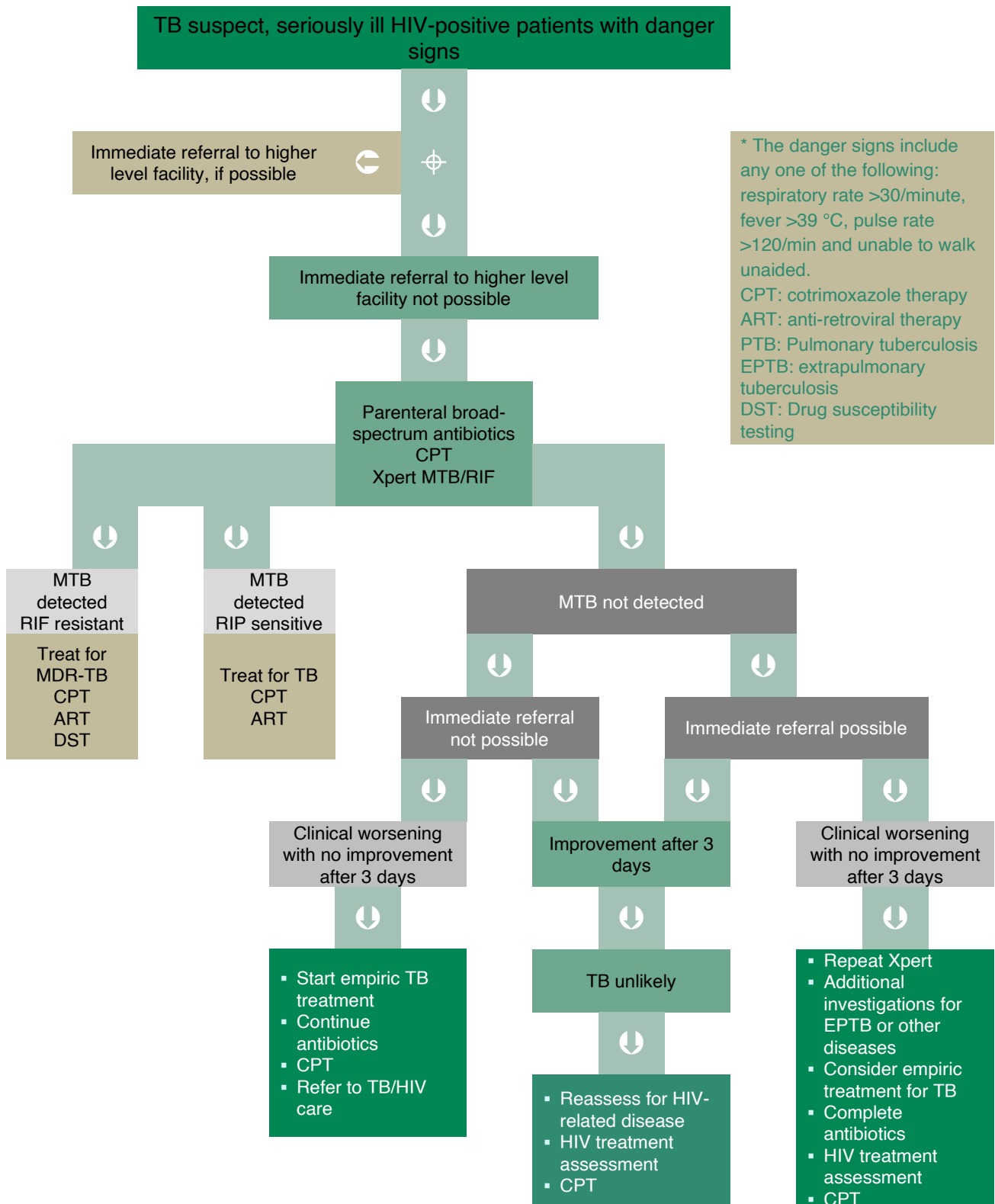

8.5. Collaborative activities between NTP and AIDS Program

Collaborative activities between NTP and national HIV/AIDS should be established. These activities aim to decrease the burden of HIV among TB patients and to decrease the burden of TB among PLHIV/AIDS, through implementation of the following activities.

8.5.1. To decrease the TB burden in people living with HIV/AIDS

Intensified tuberculosis case-finding

Tuberculosis case-finding in people living with HIV/AIDS in clinics and hospitals, household contacts, populations at high risk for HIV, and congregate settings should be intensified by increasing the awareness and knowledge of interactions between TB and HIV among health care workers and the populations they serve, and identifying TB suspects and referring them for diagnosis, systematically.

Introduce isoniazid preventive therapy

Isoniazid is given to individuals with latent infection with *M. tuberculosis* in order to prevent progression to active disease. Ruling out active tuberculosis is critically important before this therapy is started. Isoniazid preventive therapy is self-administered for 6 to 9 months, daily. Since HIV-infected people could develop tuberculosis before ART is indicated, and as there is no evidence contraindicating combined use, use of antiretroviral drugs does not preclude the use of isoniazid preventive therapy.

Ensure tuberculosis infection control in health care and congregate settings

In health care and congregate (e.g. prisons, police and military barracks) settings, where people with TB and HIV are frequently crowded together, *administrative*, *environmental* and *individual protection measures* should be implemented to reduce TB transmission. Generally, these measures aim at reducing exposure to *M. tuberculosis* of health care workers, prison staff, police agents and their clients, and any other persons living in the congregate settings.

- **Administrative measures** should enable early recognition, diagnosis and treatment of TB suspects, particularly those with pulmonary TB, and isolation of these until the diagnosis of TB is confirmed or ruled out.
- **Environmental protection** includes maximized natural ventilation and use of ultraviolet irradiation for decontamination, if applicable.
- **Individual protection** includes securing HIV-positive persons from possible exposure to TB, notably transferring a HIV-infected worker from medical wards, wearing N95 mask when moving between hospital wards, and offering isoniazid preventive therapy.

8.5.2. To decrease the burden of HIV in TB patients:

To decrease the burden of HIV in TB patients the following measures have to be implemented:

- 1 HIV testing and counselling for TB patients.

- 2 Implement HIV prevention methods.
- 3 Ensure HIV/AIDS care and support.
- 4 Initiation of antiretroviral therapy.

The policy in the Kingdom is to test all TB patients for HIV before starting anti-TB treatment and people living with HIV/AIDS have to be tested for TB (ISTC, standard 14). Individuals found to be positive for HIV and have latent TB infection should be given isoniazid preventive chemotherapy.

8.5.3. Treatment of tuberculosis among HIV positive individuals

- The top priority for HIV-positive TB patients is to be initiated on TB treatment, followed by cotrimoxazole and ART. New TB patients who are HIV positive and all TB patients living in HIV-prevalent settings should be treated with the standard daily regimens recommended for HIV negative patients throughout the whole course of treatment.
- In PLHIV with drug-susceptible pulmonary TB, who are receiving ART during TB treatment, a 6-month standard treatment regimen is recommended over an extended period of 8 months or longer.
- Two- or three-time/week regimen is not an option.
- Previously treated HIV-positive patients should receive the same retreatment regimens as HIV-negative TB patients do.
- The adverse drug reactions are likely to be more prevalent among HIV-positive than HIV-negative TB patients.
- The prognosis of TB in HIV-positive individuals is considered good, but remains worse than that of other diseases concomitant with HIV.

8.5.4. Cotrimoxazole preventive therapy

In all HIV-positive TB patients, cotrimoxazole preventive therapy should be initiated as soon as possible and given throughout TB treatment (ISTC, Standard 15). Cotrimoxazole preventive therapy substantially reduces mortality in HIV-positive TB patients. The exact mechanism of action is not clear, although cotrimoxazole is known to prevent *Pneumocystis jirovecii* and malaria and is likely to have an impact on a range of bacterial infections in HIV-positive TB patients. Supply and delivery of cotrimoxazole preventive therapy to all PLHIV with active TB should be coordinated with the national HIV/AIDS program.

8.5.5. Prevention of HIV transmission at health care facilities

In many countries, TB patients became the highest risk group for HIV infection. Therefore, it is necessary to improve safety measures in health care facilities through strict application of infection control procedures. Also, it is necessary to train all health care workers dedicated to TB control for strict and adequate use of disposable syringes and needles.

8.5.6. Antiretroviral therapy (ART)

ART improves survival in HIV-positive patients. In addition, ART reduces TB rates by up to 90% at an individual level and by 60% at a population level. It also reduces TB recurrence rate by 50%. ART should be initiated for all PLHIV with active TB disease irrespective of CD4 cell count. TB treatment should be started first,

followed by ART as soon as possible. Nonetheless, ART should be initiated within the first 2 weeks of starting TB treatment when CD4 counts \leq 50 cells/mm³ and within 8 weeks if CD4 counts \geq 50 cells/mm³.

An exception is made for patients with tuberculous meningitis, where an early initiation of ART should be decided with high a degree of caution, because of frequent adverse events and deaths reported in a randomized trial.

Administration of antiretroviral therapy has to be settled in coordination with the national HIV/AIDS program. When TB is diagnosed in patients already receiving ART, TB treatment should be started immediately. There are two issues to consider in such cases: whether ART needs to be modified because of drug–drug interactions or potential overlapping toxicity; and whether active TB in a patient on ART constitutes ART failure, hence ART regimen should be changed.

Adverse drug effects are common in HIV-positive TB patients, and some toxicities overlap between ART and TB drugs. Overlapping toxicities between ART, TB therapy and cotrimoxazole include rash and, more rarely, hepatic dysfunction. Careful monitoring of side-effects is therefore essential.

NB: TB-HIV co-infected patients should be managed in consultation by both TB and HIV experts and should be monitored for drug interaction, toxicity and response.

Reference

GLI model TB diagnostic algorithms Revised June 2018 through the website: http://www.stoptb.org/wg/gli/assets/documents/GLI_algorithms.pdf

World Health Organization. Global Tuberculosis Report 2018. https://www.who.int/tb/publications/global_report/en/

Pawlowski A, Jansson M, Sköld M, Rottenberg ME, Källenius G. Tuberculosis and HIV co-infection. *PLoS Pathog.* 2012;8(2):e1002464.

TB CARE I. International Standards for Tuberculosis Care. 3rd Edn. The Hague, TB CARE, 2014. (www.who.int/tb/publications/standards-tb-care-2014/en/, accessed 12 January 2019).

Guidelines for treatment of drug-susceptible tuberculosis and patient care (2017 update) (https://www.who.int/tb/publications/2017/dstb_guidance_2017/en/, accessed 12 January 2019)

Guidelines for treatment of tuberculosis, fourth edition. Geneva: World Health Organization; 2010 (<http://www.who.int/tb/publications/2010/9789241547833/en/>, accessed 12 January 2019)

Nahid P, Dorman SE, Alipanah N, Barry PM, Brozek JL, Cattamanchi A, et al. Official American Thoracic Society/Centers for Disease Control and Prevention/Infectious Diseases Society of America Clinical Practice Guidelines. Treatment of drug-susceptible tuberculosis. *Clin Infect Dis.* 2016;63(7):e147-95.

WHO policy on collaborative TB/HIV activities. Guidelines for national programmes and other stakeholders 2012. (Document WHO/HTM/TB/2012.1) Geneva: World Health Organization; 2012 (http://www.who.int/tb/publications/2012/tb_hiv_policy_9789241503006/en/, accessed 12 January 2019).

Consolidated guidelines on the use of antiretroviral drugs for treating and preventing HIV infection. Geneva: World Health Organization; 2016 (<http://www.who.int/hiv/pub/arv/arv-2016/en/>, accessed 12 January 2019).

9. Recording and Reporting System

9.1. Background

Detecting and reporting suspect cases of TB are the key steps in ending transmission of *M. tuberculosis*, as they enable initiating effective multiple-drugs therapy that reduces infectiousness rapidly. Delay in reporting TB cases, especially pulmonary TB, is one of the major challenges to successful control of TB. Both suspected and confirmed case of TB should be immediately reported to the Directorate of Health Affairs, by all facilities contributing in TB control activities. This represents one of the strategies to achieve the goal of reduction of TB morbidity and mortality.

The NTP requires adequate recording with periodic reporting of the data about case findings and treatment outcome. This is an essential element for planning, evaluation and follow-up of the program performance.

Data collected through recording and reporting system are used for the following purposes:

- 1 Monitor TB patterns and trends of the disease.
- 2 Identify, investigate and help control of outbreaks and epidemics.
- 3 Identify high-risk populations and settings.
- 4 Establish priorities for control and prevention activities.
- 5 Evaluate the impact of preventive and curative measures.
- 6 Improve quality-assurance.
- 7 Evaluate the program and measure the progress toward TB eradication.

According to the MOH regulation, TB is a reportable disease and should be notified as soon as the specific treatment is decided. Mandatory and timely case reporting from community sources (e.g., providers, laboratories and hospitals) should be required and evaluated regularly. Reporting enables TB control program to take action at the district and national levels and to have real time insight into the magnitude and distribution of TB in the country. Failure to report cases constitutes a threat to public health, as it may result in adverse treatment outcome and delayed investigation of contacts.

Monitoring and evaluation are integral part of TB program management and provide information on the scope, quality, scale/coverage, and success of programs.

Monitoring generally refers to the routine collection of information across time and sites in order to track a program's ongoing activities. Policy-makers use monitoring to analyze key health-related indicators, often without attributing change to any particular program or set of programs.

Evaluation involves assessment of the program implementation in order to determine the level of success in achieving predetermined outcomes/goals. Evaluation is usually carried out through a detailed analysis of the program's process and outcomes or impacts. In other words, evaluation connects outcomes to the program process and rules out unrelated outcomes.

Adequate monitoring and evaluation can only be achieved through a well-defined framework incorporating the goal, service delivery areas and activities. Indicators are needed to measure the performance and progress achieved.

It is crucial that the indicators be critically analyzed and interpreted at all levels, and that corrective action can be undertaken. Guidelines and standard operating procedures for data management, analysis and quality assurance should also be developed and adheringly used.

The NTP monitors and evaluates the implementation of the different components of the END-TB strategy through a web-based online system and patient centered approaches through mobile teams' indicators such as treatment adherence, defaulters, patient satisfaction reports etc.

NTP provides technical support in the following areas:

- Providing monitoring and evaluation plan as an integral part of the national strategic plan
- Adaptation and use of revised recording and recording system-based hard and electronic tools, through TB surveillance system. These tools cover drug-sensitive and drug-resistant TB as well as NTP and non-NTP providers from both the public and private sectors.
- Increasing capacity in data management and data quality assurance, including the general framework and tools through meetings and supervisory visits.
- Capacity strengthening in data analysis, at the national and subnational levels, including calculation and interpretation of the program indicators, evaluation of the epidemiological picture of TB control, and definition of the adequate public health actions.

Monitoring and evaluation tools

- HESN comprehensive tool covers the four main TB registers: presumptive, laboratory, TB and contacts.
- Nominal data are processed to produce routine reports and to calculate indicators.
- TB drug consumption is monitored at both regional and national levels.
- An MDR register (consistent with NTP requirements and approval) is used to generate MDR management reports.
- Systems to ensure data quality assurance and management are made available and operational.
- Additional registers for MDR-TB are implemented and used.
- Quality-assured data should be kept in the same database and as a back-up copy by exporting data to another access database.
- Four main indicators are used by mobile teams for patient-centered approach: 1) case notification, 2) sputum conversion, 3) treatment results, and 4) adherence
- **Impact measurement:** the goal of a TB surveillance system is to provide quality and comprehensive data to enable measurement of 1) TB incidence from TB notifications, and 2) TB mortality from vital registration records.

9.2. Definitions used by NTP

Presumptive TB refers to a patient who presents with symptoms or signs suggestive of TB (previously known as a TB suspect).

9.2.1. Case definitions

- A bacteriologically confirmed TB case is one from whom a biological specimen is positive by smear microscopy, culture or WRD (such as Xpert MTB/RIF). All such cases should be notified, regardless of whether TB treatment has started.
- A clinically diagnosed TB case is one who does not fulfil the criteria for bacteriological confirmation but has been diagnosed with active TB by a clinician or other medical practitioner who has decided to give the patient a full course of TB treatment. This definition includes cases diagnosed on the basis of X-ray abnormalities or suggestive histology and extrapulmonary cases without laboratory confirmation. Clinically diagnosed cases subsequently found to be bacteriologically positive (before or after starting treatment) should be reclassified as bacteriologically confirmed
- Bacteriologically confirmed or clinically diagnosed cases of TB are also classified according to:
 - anatomical site of disease;
 - history of previous treatment;
 - drug resistance;
 - HIV status.

Classification based on anatomical site of disease

- Pulmonary tuberculosis (PTB) refers to any bacteriologically confirmed or clinically diagnosed case of TB involving the lung parenchyma or the tracheobronchial tree. Miliary TB is classified as PTB because lungs are involved.
- Extrapulmonary tuberculosis (EPTB) refers to any bacteriologically confirmed or clinically diagnosed case of TB involving organs other than the lungs, e.g. pleura, lymph nodes, abdomen, genitourinary tract, skin, joints and bones, meninges.
- Tuberculous intra-thoracic (mediastinal and/or hilar) lymphadenopathy and tuberculous pleural effusion without radiographic abnormalities in the lungs are classified as EPTB.
- A patient with both pulmonary and extrapulmonary TB should be classified as PTB.

Classification based on history of previous TB treatment (patient registration group)

Updated classifications based on history of previous TB treatment are slightly different from those previously published. They focus only on history of previous treatment and are independent of bacteriological confirmation or site of disease. Note also that the registration groups for DR-TB are slightly different (see [table below](#)).

Category	Definition
New patients	Refers to patients who have never been treated for TB or taken anti-TB drugs for more than 1 month.
Previously treated patients	Refers to patients who have received anti-TB drugs for 1 month or more, by the past. They are further classified by the outcome of their most recent course of treatment as follows:
<ul style="list-style-type: none"> ▪ Relapse patients 	Refers to patients who have previously been treated for TB, were declared cured or completed their most recent course of treatment, and who are now diagnosed with a new episode of TB, either a true relapse or a new reinfection episode.
<ul style="list-style-type: none"> ▪ Treatment after failure patients 	Refers to patients who have previously been treated for TB and whose most recent course of treatment was a failure.
<ul style="list-style-type: none"> ▪ Treatment after loss to follow-up patients 	Refers to patients who have previously been treated for TB and were declared lost to follow-up at the end of their most recent course of treatment (previously classified as “treatment after default patients”).
<ul style="list-style-type: none"> ▪ Other previously treated patients 	Refers to patients who have previously been treated for TB but whose outcome after the most recent course of treatment is unknown or undocumented.
Patients with unknown previous TB treatment history	Refers to patients who do not fit into any of the above listed categories.
Remark: New and relapse cases of TB are incident TB cases.	

Classification based on HIV status

- HIV-positive TB patient refers to any bacteriologically confirmed or clinically diagnosed case of TB who has a positive result from HIV testing conducted at the time of TB diagnosis or other documented evidence of enrolment in HIV care, such as enrolment in the pre-ART register or in the ART register once ART has been started.
- HIV-negative TB patient refers to any bacteriologically confirmed or clinically diagnosed case of TB who has a negative result from HIV testing conducted at the time of TB diagnosis. Any HIV-negative TB patient who is subsequently found to be HIV-positive should be reclassified accordingly.
- HIV status unknown TB patient refers to any bacteriologically confirmed or clinically diagnosed case of TB who has no result of HIV testing and no other documented evidence of enrolment in HIV care. If the patient’s HIV status is subsequently determined, he or she should be reclassified accordingly.

Classification based on drug resistance

TB cases are classified based on drug susceptibility testing (DST) of clinical isolates that were confirmed to be *M. tuberculosis*:

- Drug-susceptible: no evidence of infection with strains resistant to rifampicin (i.e. not rifampicin-resistant or multidrug-resistant TB).
- Monoresistance: resistance to only one first-line anti-TB drug.
- Polydrug resistance: resistance to more than one first-line anti-TB drug (other than resistance to both isoniazid and rifampicin)
- Multidrug resistance: resistance to both isoniazid and rifampicin, with or without resistance to other anti-TB drugs.

- Extensive drug resistance: resistance to any fluoroquinolone and to at least one of three second-line injectable drugs (capreomycin, kanamycin and amikacin), in addition to multidrug resistance.
- Rifampicin resistance: resistance to rifampicin detected using phenotypic or genotypic methods, with or without resistance to other anti-TB drugs. It includes any resistance to rifampicin, and could be subclassified under monoresistance, multidrug resistance, polydrug resistance or extensive drug resistance.

These categories are not all mutually exclusive. When enumerating rifampicin-resistant TB (RR-TB), for instance, multidrug-resistant TB (MDR-TB) and extensively drug-resistant TB (XDR-TB) may also be included in the classification, if applicable. While the current practice limits the definitions of monoresistance and polydrug resistance to first-line drugs only, future drug regimens may require classifying patients by their respective strain resistance patterns to fluoroquinolones, second-line injectable agents and any other anti-TB drug, for which reliable DST would become available.

9.2.2. Treatment susceptibility definitions

The new treatment outcome definitions make a clear distinction between two types of patients:

- Patients treated for drug-susceptible TB, referring to patients who do not have evidence of infection with strains resistant to rifampicin (i.e. not rifampicin-resistant or multidrug-resistant TB) (*New Definition*)
- Patients treated for drug-resistant TB using second-line treatment (defined as combination chemotherapy for drug-resistant tuberculosis, which includes drugs other than those in Group 1).

The two groups are mutually exclusive. Any patient found to have drug-resistant TB and placed on second-line treatment is removed from the drug-susceptible TB outcome cohort. This implies that management of the standard TB register and second-line TB treatment register needs to be coordinated to ensure proper assessment of the treatment outcomes.

9.2.3. Outcome definitions

Treatment outcomes for all bacteriologically confirmed and clinically diagnosed TB cases should be assigned an outcome from this list; except those with RR-TB or MDR-TB, who are placed on a second-line drug regimen:

- **Cured:** A pulmonary TB patient with bacteriologically confirmed TB at the beginning of treatment who was smear- or culture-negative in the last month of treatment and, at least, in one previous follow up visit.
- **Treatment completed:** A TB patient who completed treatment without evidence of failure BUT with no record to show negative sputum smear or culture results in the last month of treatment or during one previous follow up visit, at least, either because tests were not done or because results are unavailable.

- **Treatment failed:** A TB patient whose sputum smear or culture is positive at month 5 of treatment or later.
- **Died:** A TB patient who dies for any reason before starting or during the course of treatment.
- **Lost to follow-up:** A TB patient who did not start treatment or whose treatment was interrupted for consecutive months or more.
- **Not evaluated:** A TB patient for whom no treatment outcome is assigned. This includes cases transferred out to another treatment unit as well as cases for whom the treatment outcome is unknown to the reporting unit.
- **Treatment success:** The sum of cured and treatment completed.

9.2.4. Outcomes for RR-TB/MDR-TB/XDR-TB patients treated using second-line treatment

Patients found to have an RR-TB or MDR-TB TB strain at any point in time should be initiated on adequate second-line drug regimen. These cases are excluded from the main TB cohort when calculating treatment outcomes, and are included only in the second-line TB treatment cohort analysis. In case that treatment with a second-line drug regimen is not possible, the patient is kept in the main TB cohort and assigned an outcome among the same list of outcomes. This is a change from previous practice, where such cases used to be classified as Treatment failed.

From now on, all cases on treatment will be assigned outcomes according to this revised definition.

Treatment outcome in these patients is classified as in the following table:

Outcome	Definition
Cured	Treatment completed as recommended by the national policy without evidence of failure AND three or more consecutive cultures, performed at least 3 days apart, are negative after the intensive phase.
Treatment completed	As recommended by the national policy without evidence of failure BUT no record of three or more consecutive negative cultures, performed at least 30 days apart after the intensive phase.
Treatment failed	Treatment terminated or need for permanent regimen change of at least two anti-TB drugs because of lack of conversion by the end of the intensive phase, or bacteriological reversion in the continuation phase after initial conversion to negative, or evidence of additional acquired resistance to fluoroquinolones or second-line injectable drugs, or adverse drug reactions (ADRs).
Died	A patient who dies for any reason during the course of treatment.
Lost to follow-up	A patient whose treatment was interrupted for 2 consecutive months or more.
Not evaluated	A patient for whom no treatment outcome is assigned. This includes cases transferred to another treatment unit and whose treatment outcome is unknown.
Treatment success	The sum of cured and treatment completed.

For Treatment failed, lack of conversion by the end of the intensive phase implies absence of conversion within the maximum duration of intensive phase applied by the program. If no maximum duration is defined, an 8-month cut-off is proposed. For regimens without clear distinction between intensive and continuation phases, a cut-off 8 months after the start of treatment is suggested to determine when the criteria for Cured, Treatment completed and Treatment failed may be applied.

The terms “conversion” and “reversion” of culture as used here are defined as follows:

- Conversion (to negative): culture is considered to have converted to negative when two consecutive cultures, performed at least 30 days apart, are found to be negative. In such case, the specimen collection date of the first negative culture is used as the date of conversion.
- Reversion (to positive): culture is considered to have reverted to positive when, after an initial conversion, two consecutive cultures performed at least 30 days apart are found to be positive. For the purpose of defining Treatment failed, reversion is considered only when it occurs in the continuation phase.

9.3. Codes used by NTP in recording and reporting TB patients

NB; these codes are devised by NTP in Saudi Arabia to facilitate registration of tuberculosis cases in the Kingdom and are not consistent with those used by ICDs.

Tuberculosis classification	Code	Tuberculosis classification	Code
Pulmonary TB	1	Meningitis and neurological	5
Lymphadenopathy	2	Miliary	6
Osteomyelitis	3	Genitourinary	7
Gastrointestinal	4	Others	8

9.4. Code letters for directorates of health affairs in the Kingdom

Tuberculosis classification	Code	Tuberculosis classification	Code
Riyadh	R	Makkah	M
Al-Madenah Al-Monawarah	W	Jeddah	J
Eastern Province	S	Taif	T
Aseer	A	Hail	H
Qaseem	Q	Al-Baha	B
Jazan	G	Najran	N
Tabuk	K	Northern frontier	D
Al-Jouf	F	Qonfozah	Z
Hafr El-Baten	L	Al-Hassa	E
Al-Quryiat	Y	Bishah	P

Each TB patient should have a unique code number on registration in the district tuberculosis register. This unique code is composed of the year, code letter for the district and the serial number of the patient within the district. For example; to register a patient in Riyadh region during the year 2014 with a serial number of 123, it will be as follow (14R123). The number (14) refers to the year, the letter (R) refers to the district and the number (123) refers to the serial number of the patient in the district. District coordinator must send the patient’s code number to the facility that detects and treats the patient; this code should be immediately recorded on the patient’s treatment card. No treatment card should be opened without this TB code.

9.5. General rules for recording and reporting TB cases:

- Tuberculosis register must be separated from registers of other infectious diseases.
- Records should be compiled monthly, quarterly and annually to prepare the required statistical information.
- Symbols used to fill-in data should be unified as follow:
- Do not use this symbol (-).
- Use (√) for (Yes) and (×) for (No).
- Use (POS) for (Positive), (NEG) for (Negative) and (ND) for not done.
- Do not use symbols that are not adopted by NTP, except after coordination with the central unit.
- Conduction of research studies related to tuberculosis by any organization should be coordinated with the central unit and based on an agreement to ensure NTP rights, and to generalize benefits from the research.
- All correspondences related to registration and reporting of tuberculosis cases should be done through the Director of Health Affairs or his/her assistance for Public Health.
- Records and registers should be periodically reviewed by the district coordinator and by the central unit to ensure completeness and reliability of data included.
- Relapse and treatment after failure patients must be re-registered with a new TB code that contains the previous code plus (**REL** for relapse) or (**TrAF** for treatment after failure). If the patient does not respond to re-treatment, he/she should be classified as chronic case and the previous TB code must be mentioned in front of the new one.
- In case of referral, a copy of treatment card should be attached with the referral memo (electronic or hard copy), and the referral facility must be officially notified through the available MOH systems. On the other hand, the referral facility should notify the referring facility if the patient is on regular treatment. The referral facility must use the same TB code with which the patient was referred.
- In case of transfer-out, the site or facility of referral should be recorded in the treatment outcome cell of the district register; and after completing the treatment course this note should be erased and the final treatment outcome should be recorded.
- By the end of the second/third month of treatment, some patients may not be able to give sputum; in this case the available sample collected from the patient should be sent to the laboratory.
- TB patients who do not have a legal residency permission or have temporary ones should be registered and reported with a TB code in red color as follow (14TR230), where “T” means temporary “R” is the district code, “14” is the year and “230” is the serial number in the district register.
- Referral facilities must formally notify the coordinator of the district, from which the patient has been referred, with the laboratory investigations results and treatment outcome at the end of treatment.

9.6. Registers and forms used by the NTP

9.6.1. Registers

9.6.1.1. Presumptive cases register

The *Presumptive Cases Register* is a document for recording any individual suspected to have TB or for whom sputum sample was sent for microscopy. It should be kept in the outpatient clinics and in the primary health care centers, and is used to follow-up of TB suspect management and to evaluate the facility performance in early detection of TB patients.

9.6.1.2. Laboratory register

This *Laboratory Register* should be kept in the laboratories assigned to diagnose tuberculosis. If more than one specimen is being tested during the investigation for a same patient, results are recorded on the same row, under a unique laboratory serial number (one serial number by patient, by episode). However, if a patient is tested again for another episode (e.g. 1st patient suspected for TB has a negative initial test, then presents again with TB symptoms after a few months), then test results are registered in a new row with a new laboratory serial number. Likewise, results of tests performed during treatment monitoring should be entered in separate rows.

9.6.1.3. District TB register

A TB basic management unit (TBMU) is defined in terms of management, supervision and monitoring responsibility. A TBMU for the TB program may have several treatment facilities and one or more laboratories. The defining aspect is the presence of a manager or coordinator who oversees TB control activities for the unit, and who maintains a master register of all TB patients being treated. This register is used to monitor the program and report indicators to higher administrative levels. This register must be kept by the district TB coordinator. It includes the patients TB codes, personal information, treatment and laboratory results, and follow up data. The register should start with a new number at the beginning of each calendar year with regular recording of patients' data. In the cell "treatment outcome" the date of the result should be recorded. This register is considered as the main source for follow-up and statistics related to the NTP, and a conform copy should be available at each treating unit.

9.6.1.4. Contacts register

The *Contacts Register* is used to record and monitor management of TB patients' contacts and implementation of preventive measure applied for these. The register includes a summary data about the index TB patient and data related to his/her contacts, as well as the methods used to screen these and the results of screening.

9.6.1.5. Follow-up register for tuberculosis patients in the peripheral health facilities

This register has to be kept in the peripheral health facilities (Primary health care centers) that follow-up the patient's adherence to treatment. It is very important to register the dates of touch with the patient or his/her

relatives, notably physical visits to patient's home in case the patient interrupted his treatment. Adequate record-keeping of this register is crucial to ensure strict follow up and supervision of patients' treatment.

9.6.2. Forms

9.6.2.1. Form 1: Request for smear microscopy, molecular diagnosis, and culture and DST

It is a standard form that accompanies a biological sample to laboratory for smear microscopy, Xpert MTB/RIF, culture and DST. Requests for histopathology (including cytology) should be made with the standard forms in use at the health facility. HIV status and previous treatment status are included so that the data required for assessing adherence to, and effectiveness of treatment can be collected.

In case that several types of specimen (e.g. sputum and other fluids) are sent for examination, for the same patient, a separate request form should be used for each specimen.

In case that multiple examinations (e.g. culture and DST on the same sputum sample) are requested, the results should be sent from the laboratory to the requestor in a timely manner, even separately (i.e. test by test) and not necessarily waiting until all tests results are available.

The requestor completes the upper section of the form, including basic demographics and contact details of the patient. Depending on the type of examination required, the requestor also fills in the date of sample collection in the lower part of the form.

9.6.2.2. Form 2: Notification and medical report about a tuberculosis case

This form includes demographic information about the patient, signs, symptoms, past medical history, investigations results, and classification of the patient and his treatment category.

The assigned person in the facility detecting the patient should forward this form to the district coordinator, with a cover letter, within one working day from laboratory confirmation of the diagnosis. The district coordinator should then review the form, register the patient in the district register and notify the treating facility with patient's TB code within one working day from notification.

9.6.2.3. Form 3: Monthly tuberculosis laboratory report

This report includes the results of the laboratory investigations for TB presumptive cases and patients, such as microscopy, culture, Gen Xpert MTD/Rif and DST. It has to be completed by the TB laboratory personnel and submitted to the district coordinator on a monthly basis. It should include results for all specimens examined for TB for any reason and by any method of investigation. The report enables tracing patients who are diagnosed at the laboratory but do not appear for treatment through checking the report against the TBMU register. The register could be electronic.

9.6.2.4. Form 4: Tuberculosis treatment referral/transfer form

This form should be used when referring a patient for diagnosis confirmation or treatment in another facility. It is also used in transferring a TB patient from one TBMU to another, for any reason. The form is divided into

two parts: an upper and a lower part. The upper part is filled by the referring/transferring facility, and includes date of transfer and patient's information. The lower part is a confirmation that the referred/transferred patient has been received by the facility; it has to be filled by the facility receiving the patient and sent back to the referring facility to ensure that they received the patient.

9.6.2.5. Form 5: Epidemiologic survey form for a tuberculosis case

The upper part of this form includes TB patient personal data and disease status. The lower part of the form includes data about the transmission setting and patient's contacts names and preventive measures taken toward these. The upper part should be filled-in by the treating unit, then forwarded to the nearest health facility to the patient's home (mostly primary health care centers) with a cover letter to complete the survey. The lower part has to be filled by the health facility that shall carry out the contacts investigations. A photocopy from the form should be kept at the neighborhood facility and the original copy should be sent back to the treating facility to assess contacts' health and forward the form to the district coordinator for follow-up. In final, the form should be kept in the patient's file.

9.6.2.6. Form 6: Quarterly report on transferred patients

The form includes data about TB patients referred or transferred from one TBMU to another. It should be submitted by the district coordinator to the central unit, on a quarterly basis, to ensure competent follow up of the transferred patients.

9.6.2.7. Form 7: Monthly report on Tuberculosis cases/treatment outcome

This form constitutes the standard report of cases as recorded in the TBMU register. The form has to be completed by the district coordinator and submitted to the central unit on a monthly basis, in the first week of each Gregorian month. Guidelines mentioned on the back of this form must be strictly followed while filling it in.

9.6.2.8. Form 8: Monthly report on TB suspects management

This is an aggregate report on individuals suspected to have TB. The data to be included are: type of referral, number of registered suspect cases, and number of tested ones from those registered. Results of investigations used to confirm or rule out TB, HIV statuses and number of confirmed cases who were registered for treatment are also reported in this form.

9.6.2.9. Form 9: Treatment card

Treatment card is an important form that includes summary data for the patients' status, progress and response to treatment, adherence to treatment and treatment outcome. It is divided into two sections, one for the intensive phase of treatment and the other for the continuation phase. No file for treatment of a TB patient should be opened without a treatment card included in the file containing the unique patient's TB code.

9.7. Treatment box

A box divided into nine compartments designed to facilitate monitoring adherence of patients to their follow-up appointments. Each compartment should be assigned as mentioned below. This box is under the responsibility of the person supervising patients' treatment.

Compartment one: new treatment cards

This compartment includes treatment cards for new patients waiting for drug collection. These cards should be regularly reviewed and remain in this compartment until the patient presents to collect his drugs.

Compartment two: treatment follow-up

This compartment includes treatment cards for patients on regular treatment. The cards should be reviewed daily by the person supervising treatment administration, and arranged chronologically according to patients' appointments. Cards of patients should be ordered according to the sequence of patients, from compartment's front to back. If a patient defaults on drug collection on the assigned day, the card should be moved to the next third compartment.

Compartment three: Waiting cards

This compartment includes cards for patients who default on drug collection, on the assigned day. Cards should be kept in this compartment for three days. If the patient presents again within the three days and collects his drug, the card should be moved again to compartment number two; otherwise the card is moved to compartment number four.

Compartment four: First call compartment

This compartment includes cards for patients who default for more than three days. Cards should be arranged chronologically for purpose of contacting the patient or his relatives by the person supervising the treatment. Cards for patients with whom a call is performed should be moved behind and kept in this compartment for one week. If the patient comes back and collects his drugs the card should be moved to the second compartment; otherwise it is moved to the compartment number five.

Compartment five: Second call compartment

After one week of the first call, a second call has to be performed. Subsequently, if the patient comes back and collects his drugs the card should be moved to the compartment number two; otherwise a visit to patient's home should be planned. If the patient does not come after the second call, the card should be kept in this compartment for two months and then moved to compartment number six.

Compartment six: Defaulted patients

Cards for patients who did not come over two months should be kept in this compartment, and the district coordinator should be informed.

Compartment seven: Transferred patients

Cards for patients transferred outside the district are kept in this compartment until receipt of their treatment outcomes.

Compartment eight: Cured and completed treatment patients

Cards for patients declared cured or who completed their treatment are kept in this compartment for three months (as the patient may come back for any reason), then moved to the patient's file.

Compartment nine: Deaths

Includes cards for TB patients who died, and should be kept in this compartment until identification of the cause of death, then moved to the patient's file.

Reference

World Health Organization. Global tuberculosis report 2018. ISBN 978-92-4-156564-6. WHO Library Cataloguing-in-Publication Data

Definitions and reporting framework for tuberculosis – 2013 revision (updated December 2014) <http://www.emro.who.int/pdf/tuberculosis/strategy/monitor-evaluate.pdf?ua>

10. Drug Resistant TB

10.1. Definitions

Item	Definition
Monoresistance	Resistance to one of the first line agents
Isoniazid-resistant TB (Hr-TB)	<i>M. tuberculosis</i> strains in which resistance to isoniazid and susceptibility to rifampicin have been confirmed in vitro
Rifampicin-resistant TB (RR-TB)	<i>M. tuberculosis</i> strains in which resistance to rifampicin and susceptibility to isoniazid have been confirmed in vitro
Poly-resistance	Resistance to more than one first line agents, <u>except for isoniazid and rifampin together</u>
Multidrug resistant tuberculosis (MDR)	Resistance to at least both isoniazid and rifampin [1]
Extensively drug resistant tuberculosis (XDR)	MDR + resistance to quinolones + resistance to at least one injectable drug. [2, 3]
First-line TB medicines (or drug)	Medicines used to treat drug-susceptible TB: ethambutol, isoniazid and pyrazinamide. First-line TB drugs may also be used in MDR-TB regimens
Second-line TB medicine (or drug)	An agent reserved for the treatment of drug-resistant TB. Streptomycin is now considered a second-line TB medicine and used only as a substitute for amikacin when amikacin is not available or there is confirmed resistance to it.
Longer MDR-TB regimens	Regimens used for the treatment of MDR/RR-TB, lasting 18 months or longer. They may be standardized or personalized. These regimens are usually designed to include a minimum number of second-line TB medicines considered to be effective based on patient history or drug-resistance patterns.
Shorter MDR-TB regimen	Course of treatment for MDR/RR-TB lasting 9–12 months, which is largely standardized. Composition and duration of these regimens is determined according to the documented evidence in the setting.
Serious adverse events (SAEs)	Adverse events (AEs) classified as Grade 3 (severe), Grade 4 (life-threatening or disabling) or Grade 5 (death related to AE), or which lead to permanent discontinuation of the drug. SAEs are otherwise often defined as AEs that either lead to death or a life-threatening experience; to initial or prolonged hospitalization; to persistent or significant disability; or to a congenital anomaly. The management of SAEs often requires termination of the suspected drug.
New case	Newly registered episode of TB in a patient who has never been treated for TB or who has taken anti-TB medicines for less than 1 month.
Previously treated	Patient who has previously received 1 month or more of anti-TB medicines, either with a first-line or a second-line regimen (e.g. shorter MDR-TB regimen).

10.2. Epidemiology

Drug-resistant TB continues to be a public health threat. In 2018, there were about half a million new cases of rifampicin-resistant TB, of which 78% had MDR-TB.

The three countries with the largest share of the global drug-resistant TB burden were India (27%), China (14%) and the Russian Federation (9%). Globally, 3.4% of new TB cases and 18% of previously treated

cases are MDR-TB or rifampicin-resistant TB (MDR/RR-TB), with the highest proportions reported in the former Soviet Union countries.

10.3. Risk factors

The followings are known to be associated with higher risk for MDR TB:

- a. Previously treated TB
- b. Inadequate treatment, either with inadequate regimen or duration
- c. Known HIV-positive status
- d. Patients residing or coming from MDR-TB endemic areas
- e. Patients with renal failure
- f. Exposure to known MDR-TB case

10.4. Diagnosis

Any patient who fulfils one or more of the previously listed risk factors should be considered for testing for drug resistant TB.

Additionally, resistance should be suspected in patients on therapy in the following cases:

- If non-compliance is reported.
- Smear positive at 2 and/or 3 months of treatment.
- Persistence of fever or other TB symptoms or worsening of radiological findings after 4 weeks of drug regimen.

The diagnosis of MDR/RR-TB requires bacteriological confirmation of TB and testing for drug resistance using rapid molecular tests, culture methods or sequencing technologies. There are 3 diagnostic tests available for drug susceptibility and resistance (**Table 10.1**):

- 1 Phenotypic drug susceptibility testing,
- 2 The Cepheid GeneXpert (Xpert),
- 3 Line probe assays (LPAs; e.g., Hain GenoType MTBDR*plus* 2.0 and MTBDR*s*/ 2.0).

Table 10.1. Summary of the available tests for drug susceptibility testing for MDR TB

Test	Technique	Advantages	Disadvantages
Phenotypic “Gold standard”	Culture based method using critical concentration of specific drug. Techniques vary depending on the media and protocol	Reliable and reproducible (for rifampin and INH; as well as kanamycin, amikacin, levofloxacin, ofloxacin)	Time consuming Biosafety requirements Less reproducible for Ethambutol and pyrazinamide
Xpert MTB/RIF	Molecular identification of genes associated with resistance to specific anti TB	<ul style="list-style-type: none"> Directly from clinical samples. Accepted samples are: sputum, processed sputum sediment, CSF, Lymph nodes Turnaround time <2 hours High sensitivity on smear positive 	<ul style="list-style-type: none"> Pooled sensitivity on smear negative samples is 67% and 79% on HIV-positive patients. May provide false negative results in very low bacteria load.
Line probe assays (LPAs): . MTBDRplus assay (Hain Lifescience, Nehren, Germany) . Nipro NTM + MDRTB detection kit 2 (Nipro Corporation, Tokyo, Japan)	Molecular identification of genes associated with resistance to specific anti TB	<ul style="list-style-type: none"> Detect mutation associated with resistance to INH and rifampicin Second line LPA is recommended by WHO for diagnosis of second-line resistance mutation 	<ul style="list-style-type: none"> Less reliable on smear negative samples Detected genes mutation does not necessarily imply resistance

10.5. Treatment

Current policy recommendations on treatment and care for DR-TB include:

10.5.1. Regimens for isoniazid-resistant tuberculosis (Hr-TB)

- In patients with confirmed rifampicin-susceptible and isoniazid-resistant tuberculosis, treatment with rifampicin, ethambutol, pyrazinamide and levofloxacin is recommended for a duration of 6 months.
- It is not recommended to add streptomycin or other injectable agents to the treatment regimen.

10.5.2. Composition of longer MDR-TB regimens

- Drugs that are used in longer MDR-TB regimens are classified into 3 groups: Group A, B, and C, by order of priority (**Table 10.2**).
- In MDR/RR-TB patients on longer regimens, all three Group A agents and at least one Group B agent should be included to ensure that treatment starts with at least four TB agents that are likely to be effective, and that at least three agents are included for the rest of the treatment after bedaquiline is stopped.

- If only one or two Group A agents are used, both Group B agents are to be added to complete the regimen. If the regimen cannot be composed with agents from Groups A and B alone, Group C agents are added to complete it.
- Some drugs are mutually exclusive, such as Levofloxacin with moxifloxacin, and should not be used together in the same regimen.
- Levofloxacin or moxifloxacin should be included in the treatment of MDR/RR-TB patients on longer regimens.
- Bedaquiline should be included in longer MDR-TB regimens for patients aged 18 years or more, and may also be used for patients aged 6–17 years.
- Linezolid should be included in the treatment of MDR/RR-TB patients on longer regimens.
- Ideally, longer MDR-TB regimens should include: Levofloxacin **OR** moxifloxacin + Bedaquiline + Linezolid + 1 group B drug (e.g. Clofazimine, Cycloserine **OR** Terizidone)
- The following drugs may be included with some precautions:
 - ♦ Delamanid may be included in the treatment of MDR/RR-TB patients aged 3 years or more on longer regimens.
 - ♦ Amikacin may be included in the treatment of MDR/RR-TB in patients aged 18 years or more on longer regimens when susceptibility has been demonstrated and adequate measures to monitor for adverse reactions can be ensured. If amikacin is not available, streptomycin may replace amikacin under the same conditions.
 - ♦ Ethionamide or prothionamide may be included in the treatment of MDR/RR-TB patients on longer regimens only if bedaquiline, linezolid, clofazimine or delamanid are not used or if better options to compose a regimen are not possible.
 - ♦ P-aminosalicylic acid may be included in the treatment of MDR/RR-TB patients on longer regimens only if bedaquiline, linezolid, clofazimine or delamanid are not used or if better options to compose a regimen are not possible.
- The following precautions should be noted:
 - a. Regimens containing both **bedaquiline and linezolid** were associated with significant increase of conversion rate.
 - b. Safety of the combination **bedaquiline + delamanid** has not been established from prospective trials yet; however, reports from retrospective trials were promising both in terms of efficacy and safety. It should be noted that there is risk for increased cardiac side effects (prolonged QT) with combination of these two agents.
 - c. Addition of **delamanid** to optimized drug regimen for treatment of MDR TB was not shown to increase sputum conversion compared with placebo, while it was associated with higher rate of side effects.

Table 10.2. Grouping of medicines recommended to be used in the longer MDR TB regimen

Group	Medicine	Abbreviation
<p><u>Group A:</u> Include three medicines (unless they cannot be used)</p>	Levofloxacin <u>OR</u> Moxifloxacin § Bedaquiline Linezolid	Lfx / Mfx Bdq Lzd
<p><u>Group B:</u> Add two medicines (unless they cannot be used)</p>	Clofazimine Cycloserine <u>OR</u> Terizidone §	Cfz Cs / Trd
<p><u>Group C:</u> To be added to complete the regimen, notably when medicines from Group A and B cannot be used.</p>	Ethambutol Delamanid Pyrazinamide Imipenem-cilastatin <u>OR</u> Meropenem § Amikacin <u>OR</u> Streptomycin§ Ethionamide <u>OR</u> Prothionamide § P-aminosalicylic acid	E Dlm Z Imp-Cln / Mpm Am / S Eto / Pto PAS
<p><u>Not Included</u></p>	Kanamycin Capreomycin Clavulanic acid	

§ Mutually exclusive drugs, i.e. cannot be included in the same regimen.

10.6. Important considerations

A. Cross resistance between different drug may exist:

- All Rifamycins have high level of cross-resistance
- High cross resistance between **INH** and **ethionamide** in presence of inhA mutation
- **Fluoroquinolones** have variable cross-resistance; testing of individual drugs is recommended
- **Ethionamide** and prothionamide have 100% cross-resistance
- Strains resistant to **SM** are susceptible to **AM**
- Strains resistant to **AM** and **KM** induce resistance to **SM**
- **Cycloserine** and **Terizidone** are frequently cross-resistant
- **Bedaquiline** and **clofazimine** are likely to be cross-resistant in the presence of Rv0678 and pepQ mutations

B. Pharmacokinetics & pharmacodynamics

- When possible, pyrazinamide, ethambutol and fluoroquinolones should be given once per day because the high serum levels reached with once-a-day dosing are likely to be more efficacious.
- For ethionamide, cycloserine, and PAS, the daily dose is divided into morning and evening doses for better tolerance.

C. Pyridoxine supplements

- All patients on cycloserine/terizidone should receive pyridoxine (B6). The recommended daily dose is 50 mg for every 250 mg of cycloserine/terizidone.

D. Route of medications

- a. Based on the new evidence and the last WHO recommendation, an oral, effective therapy is feasible.
- b. If a shorter regimen is deemed to be a reasonable choice, there is no evidence to support replacing the standard medications in this regimen by alternative one (e.g replacing the injectable with an oral agent such as bedaquiline or other; or replacing moxifloxacin with levofloxacin).
- c. It should be noted that reliability and reproducibility of DST for second-line agents (other than aminoglycosides and fluoroquinolones) is limited.

10.7. Strategy

- 1 All patients with suspected TB should have samples sent for microscopy, culture and drug DST.
- 2 Patients with one or more risk factors for drug resistant TB should be investigated for and treated as drug resistant tuberculosis until DST is available.
- 3 On smear-positive respiratory samples or culture-positive specimens, LPA can be used to detect resistance.
- 4 XpertMTB/RIF can be used as the initial test on sputum, CSF and lymph nodes for TB diagnosis and resistance to rifampicin detection. Note that sensitivity is not optimal in smear negative/HIV infected patients and patients with low inoculum of bacteria (please refer to **Table 10.1**).
- 5 If rifampicin resistance is detected in a patient with high risk for resistance, DST for INH, fluoroquinolones and other injectables should be considered.
- 6 DST for INH, fluoroquinolones and other injectables can be done with phenotypic testing, and molecular testing using LPA can be used, if available, to test susceptibility for second line agents.
- 7 If rifampicin resistance is detected in a patient with low risk for resistance, repeat molecular testing is recommended.
- 8 If rapid molecular test is not available and patient has risk factors for TB resistance, use of more than 4 drugs should be considered until results of testing are available.
- 9 If resistance is detected and patient does NOT have any of the exclusion criteria for short regimen, using standardized short regimen can be considered with close monitoring.
- 10 If resistance is detected and patient DOES HAVE one of the exclusion criteria, longer duration regimen should be considered.

Designing a longer regimen

- a. Include all group A and one from group B drug to be included.

- b. If group A agents cannot be used, include two of group B agents.
- c. Ethambutol and pyrazinamide can be used in the longer regimen.
- d. Amikacin to be considered if available. Close monitoring of kidney function, auditory functions and therapeutic drug monitoring.
- e. Consider ethionamide or prothionamide ONLY if bedaquiline, linezolid, clofazimine or delamanid cannot be used.
- f. Duration of intensive phase varies depending on whether injectables are used or not. When injectables are used, a 6-to-7-months intensive phase can be adequate, subject to clinical and microbiological response.
- g. Total regimen duration is 18-20 months.

Duration of MDR/RR-TB regimens

- 1 The duration of longer MDR-TB regimens:
 - In, A total treatment duration of 18–20 months is suggested for most MDR/RR-TB patients on longer regimens; the duration may be modified according to the patient’s response to therapy.
 - A treatment duration of 15–17 months is suggested after culture conversion; the duration may be modified according to the patient’s response to therapy.
 - In MDR/RR-TB longer regimens that contain amikacin or streptomycin, an intensive phase of 6–7 months is suggested for most patients; the duration may be modified according to the patient’s response to therapy.
- 2 Use of the standardized, shorter MDR-TB regimen:
 - A shorter MDR-TB regimen of 9–12 months may be used instead of the longer regimen in MDR/RR-TB patients who have not been previously treated for more than 1 month with second-line medicines used in the shorter MDR-TB regimen or in whom resistance to fluoroquinolones and second-line injectable agents has been excluded.

Other specific considerations

- 1 In patients with suspected CNS disease, choose imperatively medications with adequate penetration to CNS. **Table 10.3** summarizes penetration to CNS of different anti-TB drugs.
- 2 Adjunctive therapy with steroids can be used in MDR tuberculous CNS infection or pericarditis.
- 3 Choice of medications in cases of mono or polyresistance is shown in **Table 10.4**.
- 4 Side effects should be closely monitored. **Table 10.5** summarizes the most common side effects by drug.
- 5 Management of the most common or serious side effects is summarized in **Table 10.6**.
- 6 The following side effects should be given the highest attention:
 - i Prolonged QT with bedaquiline may increase risk of cardiac side effects and mortality. No safety data on prolonged use >6 months.
 - ii FDA released a new alert for fluoroquinolones regarding increased risk of aortic tear and aortic rupture. High-risk patients include those having peripheral atherosclerotic vascular

diseases, hypertension, or genetic conditions such as Marfan syndrome and Ehlers-Danlos syndrome, as well as the elderly.

10.8. Investigations to be done at baseline

- a. Acid-fast smear, mycobacterial cultures and DST to rifampicin and isoniazid. Whenever possible, cases of rifampicin-resistant TB (RR-TB) and MDR-TB should undergo DST to second-line drugs.
- b. Chest radiography.
- c. HIV screening test (repeat if suspicion is high)
- d. If HIV positive, do complete blood count and CD4 (CD4% in children).
- e. Pregnancy test for women of childbearing age.
- f. Renal and hepatic profile
- g. Thyroid function test for all patients, if readily available. Otherwise, free thyroxine (FT4) and thyroid stimulating hormone (TSH) tests should be performed in presence of symptoms of hypothyroidism or goiter an in advanced-age patients.
- h. Full blood count if anemia is suspected.
- i. Calcium and Magnesium if on bedaquiline or delamanid
- j. Fasting blood glucose, if on gatifloxacin
- k. Audiometry
- l. Baseline EKG if on bedaquiline or belamanid

10.9. Investigations to be monitored

See (Table 10.7)

Table 10.3. Summary of anti TB penetration to cerebrospinal fluid (CSF)

Penetration to CSF	Drugs
Good	Isoniazid Pyrazinamide, Prothionamide/ethionamide Cycloserine Linezolid Imipenem (caution with children)
Variable	Flouroquinolones (better with Moxifloxacin)
Poor	Kanamycin Amikacin Streptomycin PAS Ethambutol
Not determined or no data	Capreomycin Clofazimine Clarithromycin Bedaquiline Delamanid

Table 10.4. Choice and duration of therapy for mono and polyresistant TB once DST results are available

Drug resistance pattern	Drug choice	Regimen Duration	Comments
H S	R, Z and E (\pm FQ)	6-9 months	XpertMTB/RIF/Rif to be repeated at 0,2,3 months. If resistance is detected, switch to MDR regimen.
H and E (\pm S)	R, Z, and FQ	9-12 months	XpertMTB/RIF/Rif to be repeated at 0,2,3 months. If resistance is detected, switch to MDR regimen.
H, E, Z, (\pm S)	R, FQ + Linezolid. Consider injectables or bedaquiline for the first 2-3 months to enhance sputum sterilization.	18 months	XpertMTB/RIF/Rif to be repeated at 0,2,3 months. If resistance is detected, switch to MDR therapy. If culture is positive at 2 months, then repeat testing to first- and second-line drugs.

Isoniazid (H), Rifampicin (R), Ethambutol (E), Pyrazinamide (Z), Streptomycin (S), FQ flouroquinolones.

Table 10.5. Side effects to anti TB medications

Drug	Common Side Effects	Serious Side Effects
Levofloxacin and moxifloxacin	<ul style="list-style-type: none"> ▪ Headache ▪ Insomnia ▪ Nausea, vomiting and diarrhea 	<ul style="list-style-type: none"> ▪ Prolonged QTc ▪ Dysglycemia ▪ Psychosis ▪ Seizure ▪ Liver failure ▪ Tendinitis and tendon rupture
Bedaquiline	<ul style="list-style-type: none"> ▪ Chest pain ▪ Elevated liver enzymes ▪ Arthralgia 	<ul style="list-style-type: none"> ▪ Increase mortality (no safety data beyond 6 months) ▪ QTc prolongation ▪ Liver failure
Linezolid	<ul style="list-style-type: none"> ▪ Diarrhea ▪ Leukopenia and thrombopenia ▪ Hyperlipasemia ▪ Lactic acidosis 	<ul style="list-style-type: none"> ▪ Caution: Serotonin syndrome with concurrent use of MAO or within 2 weeks
Clofazimine	<ul style="list-style-type: none"> ▪ Skin and body discoloration ▪ Hypersensitivity 	<ul style="list-style-type: none"> ▪ QTc prolongation and Torsades de pointes ▪ Suicidal ideation ▪ May accumulate in intra- abdominal organs (splenic infarctions, intestinal obstruction)
Cycloserine	<ul style="list-style-type: none"> ▪ Hypersensitivity reactions ▪ Elevated liver enzymes 	<ul style="list-style-type: none"> ▪ Dose related CNS toxicity (seizure, psychosis, depression) ▪ Cardiac arrhythmia
Terizidone	<ul style="list-style-type: none"> ▪ Dizziness ▪ Headache ▪ Tremors ▪ Insomnia 	<ul style="list-style-type: none"> ▪ CNS side effects (depression, psychosis) ▪ Suicidal ideation ▪ *SHOULD NOT BE GIVEN TO PATIENTS WITH SEIZURE
Ethambutol	<ul style="list-style-type: none"> ▪ Color vision change ▪ Reduced visual acuity ▪ Abnormal liver enzymes 	<ul style="list-style-type: none"> ▪ Hepatitis ▪ Cutaneous reactions ▪ Peripheral neuropathy
Delamanid	<ul style="list-style-type: none"> ▪ Headache ▪ Insomnia ▪ Hypokalemia ▪ Nausea, vomiting, diarrhea tinnitus 	<ul style="list-style-type: none"> ▪ If headache and/or tremor, patients should refrain from operating heavy machinery ▪ QTc prolongation: increases slowly over 6-10 weeks then stabilizes
Pyrazinamide	<ul style="list-style-type: none"> ▪ Transient liver enzymes elevation ▪ Hyperuricemia and Gout ▪ Nausea, vomiting ▪ Arthralgia 	<ul style="list-style-type: none"> ▪ Hepatotoxicity
Imipenem-cilastatin Meropenem	<ul style="list-style-type: none"> ▪ Confusion ▪ Cytopenia and neutropenia ▪ Increase liver enzymes and bilirubin 	<ul style="list-style-type: none"> ▪ Seizure ▪ Clostridium difficile infection
Amikacin/streptomycin/ kanamycin and Capreomycin	<ul style="list-style-type: none"> ▪ Ototoxicity, hearing damage ▪ Vestibular disturbance ▪ Nephrotoxicity: abnormal renal function tests 	<ul style="list-style-type: none"> ▪ Renal failure requiring dialysis
Ethionamide and prothionamide	<ul style="list-style-type: none"> ▪ Orthostatic hypotension ▪ Goiter and hypothyroidism ▪ Leukopenia and thrombocytopenia ▪ Elevated liver enzymes and bilirubin 	<ul style="list-style-type: none"> ▪ Hepatotoxicity
PAS	<ul style="list-style-type: none"> • Gastrointestinal reactions • Hepatitis, Drug fever • Cutaneous reactions • Retinopathy 	Intestinal obstruction

Table 10.6. Management of adverse events

Adverse event	Suspected drug	Management
Drug hypersensitivity reaction	All drugs	<ul style="list-style-type: none"> ▪ If anaphylaxis/Steven Johnson syndrome or toxic epidermal necrolysis stop offending drug and DO NOT re-challenge ▪ If minor drug rash, treat symptomatically
Abdominal pain	PAS, Eto, Pto, Cfz	<ul style="list-style-type: none"> ▪ Rule out pancreatitis/lactic acidosis/hepatitis or intestinal obstruction ▪ For severe abdominal pain one of 3 possible approaches can be done: ▪ Stop offending drug for 7 days, then re-challenge ▪ Decrease dose of the offending drug, unless the treatment is compromised ▪ Stop offending drug, unless the treatment is compromised ▪ For gastritis consider H-2 blockers or proton pump inhibitors
Hepatitis	Z, H, R, Pto / Eto, and PAS	<ul style="list-style-type: none"> ▪ If ≥ 5 times normal: stop all hepatotoxic drugs and keep 3 non-hepatotoxic ones. ▪ If hepatitis does not improve or worsen, stop all drugs ▪ Rule out other causes of hepatitis (viral, alcoholic hepatitis) ▪ Consider stopping offending drug permanently and introduce others gradually with close monitoring
Tendinitis or tendon rupture	Fluoroquinolones	<ul style="list-style-type: none"> ▪ If treatment can be continued without fluoroquinolones, stop the offending drug and advise joint rest + use of non-steroidal anti-inflammatory drugs. ▪ If treatment CAN NOT be continued without fluoroquinolones, strict joint rest and explain tendon rupture to patient
Nephrotoxicity	S, Km, Am	<ul style="list-style-type: none"> ▪ Stop injectable ▪ Rule out other potential causes ▪ Replace injectable with other drugs if needed
Suicidal ideation	CS, H, Eto/Pto	<ul style="list-style-type: none"> ▪ Manage in inpatient setting ▪ Discontinue cycloserine ▪ Psychiatry consultation ▪ Initiate antidepressants
Psychiatric symptoms	Cs, H, fluoroquinolones	<ul style="list-style-type: none"> ▪ Stop offending drug awaiting full psychiatric evaluation ▪ Consult psychiatrist ▪ If moderate to severe symptoms, initiate antipsychotic medicine ▪ Increase dose of pyridoxine to maximum (200 mg) ▪ Decrease dose of offending drug, if needed, to continue treatment regimen (if this does not compromise treatment)
Seizure	Cs, H, fluoroquinolones	<ul style="list-style-type: none"> ▪ Hold offending agents until seizure is controlled ▪ Initiate anti-seizure medications ▪ Increase dose of pyridoxine to maximum (200 mg) ▪ DO NOT restart cycloserine unless it is absolutely needed
Optic neuritis	E, Eto/Pto, Lzd, Cfz, rifabutin, H, S	<ul style="list-style-type: none"> ▪ Stop ethambutol and DO NOT re-challenge ▪ Refer to ophthalmology
QTc prolongation	Bdq, Dlm, fluoroquinolones, Clarithromycin, Clofazimine	<ul style="list-style-type: none"> ▪ Stop Bdq, Dlm if QTc >500 ▪ Check electrolytes

Table 10.7. Investigations that need to be monitored frequently

Test	Frequency	High risk patients who need more frequent testing
Serum creatinine and Potassium	Monthly while on injectable drugs	<ul style="list-style-type: none"> • Every 3 weeks in HIV • Diabetic • Consider more frequent monitoring in patients with abnormal baseline serum Creatinine
Serum Calcium or Magnesium	Monthly while on bedaquiline or delamanid. If low, repeat EKG.	
Thyroid function test	<ul style="list-style-type: none"> • Every 3 months if on ethionamide or prothionamide AND P-aminosalicylic acid. • Every 6 months if on ethionamide or prothionamide OR P-aminosalicylic acid 	
Liver function test	1-3 months if on pyrazinamide for extended periods	<ul style="list-style-type: none"> – Monthly if: <ul style="list-style-type: none"> • HIV • On Bedaquiline – Every 1-2 weeks for the first month, then every 1-4 weeks, if viral hepatitis
CBC	Weekly for first one month then monthly If on linezolid	If HIV and on Zidovudine monthly for first few months then as clinically indicated
Lipase		If abdominal pain on linezolid or bedaquiline
Lactic acid		If acidosis on linezolid and ART
Blood glucose		If on gatifloxacin, monitor fasting blood glucose monthly
Audiometry		Monthly if on injectable
Vision test		<ul style="list-style-type: none"> • Color test if on ethambutol and vision changes reported • Visual acuity if on linezolid and vision changes reported
EKG		<ul style="list-style-type: none"> • At 2,4,8,12 months and 24 weeks, if on bedaquiline or delamanid • Repeat monthly if on other agents that prolong QTc

Reference

- Al Ammari, M., et al., Drug resistant tuberculosis in Saudi Arabia: an analysis of surveillance data 2014-2015. *Antimicrob Resist Infect Control*, 2018. 7: p. 12.
- Al-Hajoj, S., et al., Epidemiology of antituberculosis drug resistance in Saudi Arabia: findings of the first national survey. *Antimicrob Agents Chemother*, 2013. 57(5): p. 2161-6.
- Aung, K.J., et al., Successful '9-month Bangladesh regimen' for multidrug-resistant tuberculosis among over 500 consecutive patients. *Int J Tuberc Lung Dis*, 2014. 18(10): p. 1180-7.
- Caminero, J.A., Extensively drug-resistant tuberculosis: is its definition correct? *Eur Respir J*, 2008. 32(5): p. 1413-5.
- Dorman, S.E., et al., Xpert MTB/RIF Ultra for detection of *Mycobacterium tuberculosis* and rifampicin resistance: a prospective multicentre diagnostic accuracy study. *Lancet Infect Dis*, 2018. 18(1): p. 76-84.
- Gilpin, C., A. Korobitsyn, and K. Weyer, Current tools available for the diagnosis of drug-resistant tuberculosis. *Ther Adv Infect Dis*, 2016. 3(6): p. 145-151.
- Heyckendorf, J., et al., What Is Resistance? Impact of Phenotypic versus Molecular Drug Resistance Testing on Therapy for Multi- and Extensively Drug-Resistant Tuberculosis. *Antimicrob Agents Chemother*, 2018. 62(2).
- Li, Y., F. Sun, and W. Zhang, Bedaquiline and delamanid in the treatment of multidrug-resistant tuberculosis: Promising but challenging. *Drug Dev Res*, 2018.
- Nguyen, T.V.A., et al., Bedaquiline Resistance: Its Emergence, Mechanism, and Prevention. *Clin Infect Dis*, 2018. 66(10): p. 1625-1630.
- Ocheretina, O., et al., False-positive rifampin resistant results with Xpert MTB/RIF version 4 assay in clinical samples with a low bacterial load. *Diagn Microbiol Infect Dis*, 2016. 85(1): p. 53-5.
- Organization, W.H. [cited 2019 8/2/2019]; Available from: <https://www.who.int/tb/areas-of-work/drug-resistant-tb/global-situation/en/>.
- Organization, W.H., 2016.
- Organization, W.H.; Available from: <https://www.who.int/tb/areas-of-work/monitoring-evaluation/mdr-tb-surveillance/en/>.
- Piubello, A., et al., High cure rate with standardised short-course multidrug-resistant tuberculosis treatment in Niger: no relapses. *Int J Tuberc Lung Dis*, 2014. 18(10): p. 1188-94.
- Seaworth, B.J., Multidrug-resistant tuberculosis. *Infect Dis Clin North Am*, 2002. 16(1): p. 73-105.
- Sohn, H., et al., Xpert MTB/RIF testing in a low tuberculosis incidence, high-resource setting: limitations in accuracy and clinical impact. *Clin Infect Dis*, 2014. 58(7): p. 970-6.
- Steingart, K.R., et al., Xpert(R) MTB/RIF assay for pulmonary tuberculosis and rifampicin resistance in adults. *Cochrane Database Syst Rev*, 2014(1): p. CD009593.
- Varghese, B. and S. Al-Hajoj, First Insight Into the Fluoroquinolone and Aminoglycoside Resistance of Multidrug-Resistant *Mycobacterium tuberculosis* in Saudi Arabia. *Am J Trop Med Hyg*, 2017. 96(5): p. 1066-1070.
- Von Groote-Bidlingmaier, F., et al., Efficacy and safety of delamanid in combination with an optimised background regimen for treatment of multidrug-resistant tuberculosis: a multicentre, randomised, double-blind, placebo-controlled, parallel group phase 3 trial. *Lancet Respir Med*, 2019.
- WHO consolidated guidelines on drug-resistant tuberculosis: <https://www.who.int/tb/publications/2019/consolidated-guidelines-drug-resistant-TB-treatment/en/>
- Zeka, A.N., S. Tasbakan, and C. Cavusoglu, Evaluation of the GeneXpert MTB/RIF assay for rapid diagnosis of tuberculosis and detection of rifampin resistance in pulmonary and extrapulmonary specimens. *J Clin Microbiol*, 2011. 49(12): p. 4138-41

11. BCG Vaccination

11.1. Background

Bacille Calmette-Guérin (BCG) vaccines are among the oldest vaccines, which were first used in humans in 1921. BCG is a viable bacterial attenuated vaccine derived from *M. bovis*. Since the 1920s, the original BCG strain has been elaborated under different conditions, in different laboratories worldwide, resulting in over 10 manufactured strains.

While BCG has demonstrated significant effectiveness in several populations, its protection level is not consistent against all forms of TB and in all age groups. BCG vaccination during the neonatal period provided 82% protection against TB; while in school-age TST-negative children BCG was 64% protective against PTB. Moreover, there is no evidence of effectiveness of BCG in post-exposure prophylaxis. Therefore, several new TB candidate vaccines are in development, some of which are in advanced clinical trials. Some are designed to be used as immunization booster following neonatal BCG vaccination. For leprosy, a few candidate vaccines are in development. There are currently no vaccine candidates for Buruli ulcer or other NTM infections. BCG is also used as treatment against bladder cancer.

The WHO recommends that all BCG vaccines used in immunization programmes adhere to WHO standards. In countries relating to WHO, the Russian (Moscow-368), Bulgarian sub-strain (Sofia SL222) and Tokyo 172-1 strains are the most frequently used currently.

In the Kingdom of Saudi Arabia, BCG vaccine is part of the Expanded Program on Immunization and is given free of charge to all infants at birth. It is administered at 6 months after birth according to national consultancy committee of vaccination. It has to be administered carefully with all possible precautions.

11.2. BCG vaccine indicators

The WHO recommends BCG vaccination “in countries or settings with a high incidence of TB and/or high leprosy burden as well as where Buruli ulcer occurs. A single dose should be given to all healthy infants 6 months of age. If the vaccine cannot be administered at birth, it should be given at the earliest opportunity thereafter.”

Countries with low incidence of TB or leprosy may choose to selectively vaccinate high-risk neonates. Additionally, countries with declining rates of TB are encouraged to evaluate the epidemiology of TB and leprosy and consider a switch to selective risk group vaccination.

Studies have shown minimal or no evidence of any additional benefit of repeat BCG vaccination against TB or leprosy. Therefore, revaccination is not recommended even if a TST reaction or an IFN- γ release assay (IGRA) result is negative.

11.3. Vaccination of older groups and special populations, contraindications & precautions

- BCG vaccination is recommended for unvaccinated, TST-negative or IGRA-negative school children for those coming from or moving to high incidence/burden settings.
- BCG is recommended in older groups at risk through occupational exposure.
- As a precaution, BCG vaccination is not recommended during pregnancy.
- BCG vaccination is contraindicated for immunocompromised persons and for patients undergoing immunosuppressive treatment.
- Infants exposed to immunosuppressive treatment in utero or via breastfeeding should not receive BCG.
- Children who are HIV-infected should not receive BCG vaccination. However, if HIV-infected individuals, including children, are receiving ART, are clinically well and immunologically stable they should be vaccinated with BCG.
- Neonates born to women of unknown HIV status should be vaccinated.
- Neonates with unknown HIV status born to HIV-infected women should be vaccinated if they have no clinical evidence suggestive for HIV infection, regardless of whether the mother is receiving ART.
- Neonates with HIV infection should have BCG vaccination delayed until ART is started and they are immunologically stable.
- Neonates born to mothers with pulmonary TB should receive BCG vaccination if they are asymptomatic, have no immunological evidence of TB, and are HIV-negative.
- BCG vaccine cannot be given in the following cases:
 - a. A past history of TB,
 - b. A positive pre-immunization TST,
 - c. A previous anaphylactic reaction to vaccine component,
 - d. Compromised immunity due to treatment or disease,
 - e. Generalized septic skin conditions,
 - f. Acute illnesses with fever or systemic upset.
- NB. Malnutrition and prematurity are not contraindications for BCG vaccination. Although evidence is limited, moderate-to-late preterm (gestational age >31 weeks) and low birth weight (<2500 g) infants, who are healthy and clinically stable, can receive BCG vaccination at birth, or at the latest upon discharge from the neonatal ward to the community.

11.4. Storage and validity

- The vaccine should be stored at 2-8° in the refrigerator.
- The vaccine should not be used after the expiry date shown on the bottle.
- The vaccine should not be exposed to direct sunlight or heat.
- The vaccine should be injected within four hours after dilution.
- Do not freeze
- The manufacturer's instructions accompanied with the vaccine should be strictly followed.

11.5. Reconstitution of BCG Vaccine SSI (10-dose vial)

- Transfer exactly 1.0 ml Sauton solution to the vial, using a sterile syringe with a long needle.
- Do not remove the rubber stopper
- To suspend the vaccine, turn the vial gently upside down a few times (Do not shake).
- The suspension should be homogenous, slightly opaque and colorless.
- Any reconstituted vaccine not used during a maximum 4 hours should be discarded.



11.6. Dosage

- 0.05 ml for neonates and children below one-year age (vaccine has to be diluted in 1 ml of diluent and 0.05 ml of the diluted vaccine is used).
- 0.1 ml for children more than one year of age (the vaccine has to be diluted in 1 ml diluent and 0.1ml of the diluted vaccine is used).
- Sterilized 26mm gauge syringe should be used.
- BCG vaccine is not available in combination with other vaccines.
- The vaccine should not be exposed to direct sunlight or heat and should be stored at temperatures between 2 °C and 8 °C.

11.7. Injection site

- 1 The recommended site of injection, in all age groups, is the deltoid region of the arm, in the upper third of the arm over the insertion of the deltoid muscle.
- 2 Alcohol should not be used for disinfection of the vaccination site.
- 3 If the vaccine was correctly administered, erythema will occur at the site of administration, followed by pustule formation containing yellow fluid, which then dries leaving a permanent scar.



11.8. Dosage of BCG vaccine

- For infants below 12 months, **0.05 ml** of the reconstituted vaccine is recommended.
- For children older than 12 months and adults, **0.10 ml** of the reconstituted vaccine is recommended.

11.9. Injection technique

- Gently swirl the vial before drawing up each dose.
- Draw up slightly more than one dose and remove any air bubbles and extra vaccine.
- Jet injectors or multiple puncture devices should not be used.
- The skin should not be cleansed with antiseptic before the injection.
- The skin is stretched between the thumb and forefinger.
- The needle should be almost parallel to the skin surface and the bevel of the needle facing upwards.
- The needle should only be inserted 2 mm approximately into the superficial layers of the dermis.
- The vaccine is injected slowly.
- You will feel a slight pressure as you press the plunger, and a small flat swelling will appear (very similar to a mosquito bite)
- If the skin does not swell or you feel you can press the plunger too easily, then the vaccine is probably being injected too deeply.
- If you find that the needle is subcutaneous or intramuscular do the following:
 - Stop injection and correct the needle.
 - Give the remaining amount of the dose and do not increase it.
 - If you ensure that the entire dose was subcutaneous or intramuscular, do not repeat injection.
 - Carefully follow up the child for complications.

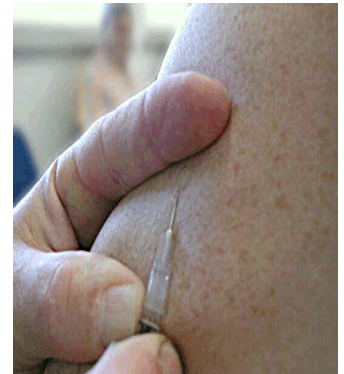

11.10. After injection

- The swelling will disappear **within 10 to 15 minutes**.
- If there is no swelling, **never give a second dose** of vaccine.
- Vaccine injected too deeply provides adequate results in terms of clinical protection. However, a large scar, abscess or enlarged lymph nodes may result from a vaccination given deeply.
- Make a note on the person's chart for careful follow-up.

11.11. Adverse effects

About 95% of BCG vaccine recipients experience a reaction at the injection site.

11.11.1. Mild adverse effects

- An injection site reaction characterized by a papule, which may be red, tender and indurated. The papule commences two weeks or later following vaccination, and may progress to ulceration. It resolves after 2-5 months, leaving a superficial scar (Fig. A).
- Swelling of the ipsilateral regional lymph nodes may also occur (usually axillary but may also be cervical and/or supra-clavicular). However, the lymph nodes remain small (< 1.5cm) and do not adhere to overlying skin (Fig. B).



FIG. A



FIG. B

11.11.2. Severe adverse effects

Severe adverse events are generally caused by:

- Poor vaccination technique.
- Excessive dose.
- Immunization of tuberculin-positive patients.

Local adverse effects include:

- **Injection site reactions:** Reactions that have been reported include local sub-cutaneous abscess and keloids (thickened scar tissue).
- **Skin lesions distinct from the vaccination site:** Tuberculosis infection can cause a number of cutaneous lesions such as TB chancre, lupus vulgaris, scrofuloderma, papulonecrotic tuberculids etc. It is important to note that multiple cutaneous lesions may signal disseminated BCG disease usually in an immunocompromised host.
- **Lymphadenitis:** When severe, this includes nodes which become adherent to overlying skin with or without suppuration. The onset of suppuration may be variable, ranging from one week to 11 months following vaccination.

Systemic adverse events

- **Osteitis and Osteomyelitis:** This is a rare and severe complication of BCG vaccination which has primarily been reported in Scandinavia and Eastern Europe. It is typically associated with changes in BCG vaccine strain.
- **Disseminated BCG disease or systemic BCG-itis:** This recognized, however, rare condition is traditionally seen in individuals with severe cellular immunodeficiencies.
- **Immune reconstitution inflammatory syndrome (IRIS):** Recently identified as a BCG vaccine-related adverse event, this condition is observed in HIV patients initiated on ART. It usually occurs within 3 months of immune restoration and presents as a local abscesses or regional lymphadenitis usually without dissemination. The etiology is unknown, but postulated to be a deregulated inflammatory reaction directed against opportunistic pathogens including mycobacterial organisms, following immune reconstitution.

11.12. BCG vaccination and other vaccines

There is evidence that BCG vaccine can be safely co-administered with diphtheria-pertussis-tetanus (DTP), polio, hepatitis B, Haemophilus influenzae type b (Hib) and measles and rubella vaccines, as well as hepatitis B birth dose. There is no evidence to suggest reduced immunogenicity, and no safety concerns have been reported.

11.13. Management of BCG vaccination adverse effects

- Clean and disinfect the site of vaccination.
- Medical therapy for lymphadenopathy is not routinely indicated. However, therapy for suppurative lymphadenitis and abscess formation at the injection site is often recommended.
- Surgical drainage of suppurative lymphadenitis remains controversial, with no good data to support the use of routine incision and drainage, removal, or simple needle aspiration.
- The use of isoniazid and erythromycin for the resolution of abscess formation remains inconclusive.
- The following programmatic approach is recommended:
 - The parents should be reassured about the usual benign course of such reactions. In many cases, such reassurance will be adequate.
 - Under parents' pressure to have the physician do something, there may be benefit to give a short course of cloxacillin or erythromycin syrup in case of evidence suggesting a superimposed bacterial infection.
 - Isoniazid is rarely prescribed, unless there is clear evidence of a suppurative reaction and associated lymphadenopathy.
 - Rarely, if an enlarged lymph node becomes tense and fluctuant, it may need to be incised and drained.

12. Latent Tuberculosis

12.1. Definitions

Latent tuberculosis infection (LTBI) is defined as a state of persistent immune response to stimulation by *Mycobacterium tuberculosis* antigens with no evidence of clinically manifest active TB. There is no gold standard test for LTBI.

Note: The definitions listed below are in accordance to the WHO *Latent tuberculosis infection updated and consolidated guidelines for programmatic management 2018*.

Item	Definition (WHO)
Adolescent	A person aged 10–19 years
Adult	A person over 19 years of age
Bacteriologically confirmed TB	TB diagnosed in a biological specimen by smear microscopy, culture or a WHO-approved molecular test such as Xpert MTB/RIF
Child	A person under 10 years
Contact	Any person who was exposed to a case of TB (see definition below)
Contact investigation	A systematic process for identifying previously undiagnosed cases of TB among the contacts of an index case. In some settings, the goal includes testing for LTBI to identify candidates for preventive treatment. Contact investigation consists of identification and prioritization and clinical evaluation.
High-TB-incidence country	A country with a WHO-estimated TB incidence rate of $\geq 100/100\ 000$
Household contact	A person who shared the same enclosed living space as the index case for one or more nights or for frequent or extended daytime periods during the 3 months before the start of current treatment
Index case (index patient) of TB	The initially identified case of new or recurrent TB in a person of any age, in a specific household or other comparable setting in which others may have been exposed. An index case is the case on which a contact investigation is centred but is not necessarily the source case.
Infant	A child below 1 year of age
Latent tuberculosis infection (LTBI)	A state of persistent immune response to stimulation by <i>M. tuberculosis</i> antigens with no clinical evidence of active TB. There is no gold standard test for direct identification of <i>M. tuberculosis</i> infection in humans. The vast majority of infected people have no signs or symptoms of TB but are at risk for active TB disease.
Low-TB-incidence country	Country with a WHO-estimated TB incidence rate of < 100 per 100 000 population
Preventive treatment	Treatment offered to individuals who are considered to be at risk for TB disease in order to reduce that risk. Also referred to as LTBI treatment or preventive therapy
Tuberculosis (TB)	The disease state due to <i>Mycobacterium tuberculosis</i> . In this document, it is commonly referred to as “active” TB or TB “disease” in order to distinguish it from LTBI

12.2. Identification and treatment of populations at risk for LTBI

Adults, adolescents, children and infants living with HIV

- Adults and adolescents living with HIV, with unknown or positive TST, who are unlikely to have active TB should receive preventive treatment of TB as part of a comprehensive package of HIV care. Treatment should be given to this category of individuals irrespective of the degree of immunosuppression, and regardless of whether they are on ART or have previously been treated for TB. It should also be given to pregnant women. (*Strong recommendation, high-quality evidence. Existing recommendation*).
- Infants aged < 12 months living with HIV who are in contact with a case of TB and are investigated for TB should receive 6 months of isoniazid preventive treatment (IPT) if the investigation shows no TB disease. (*Strong recommendation, moderate-quality evidence. Updated recommendation*).
- Children aged ≥ 12 months living with HIV who are unlikely to be having TB disease (on the basis of screening for symptoms), and who have no contact with a case of TB should be given 6 months of IPT as part of a comprehensive package of HIV prevention and care, if they live in a setting with a high prevalence of TB. (*Strong recommendation, low-quality evidence. Existing recommendation*).
- All children living with HIV who have successfully completed treatment for TB disease may receive an additional 6-month isoniazid therapy. (*Conditional recommendation, low-quality evidence. Existing recommendation*).

Pregnant women living with HIV

- Pregnant women living with HIV are at risk for TB, which can have severe consequences for both the mother and the fetus. As isoniazid and rifampicin, the drugs commonly used in preventive treatment, are safe for use in pregnant women, pregnancy should not disqualify women living with HIV from receiving preventive treatment. Nevertheless, sound clinical judgement is required to determine the best time to provide it.
- There is no evidence supporting the relevance of repeated courses of preventive treatment, and hence no such recommendation is made in the present guidelines. However, in settings with high TB transmission (as defined by local authorities), IPT for 36 months or longer is recommended, under certain conditions.

HIV-negative household contacts of persons with PTB

- HIV-negative children aged <5 years who are household contacts of people with bacteriologically confirmed PTB and who are found NOT to have active TB on an appropriate clinical evaluation or according to national guidelines should be given TB preventive treatment. (*Strong recommendation, high-quality evidence. Updated recommendation*)
- In low TB incidence areas, adults, adolescents and children who are household contacts of people with bacteriologically confirmed PTB should be systematically tested and treated for LTBI. (*Strong recommendation, high-moderate-quality evidence. Existing recommendation*)

- In high TB incidence areas, children aged ≥ 5 years, adolescents and adults who are household contacts of people with bacteriologically confirmed PTB, and who are found NOT to have active TB by an appropriate clinical evaluation or according to national guidelines may be given TB preventive treatment. (*Conditional recommendation, low-quality evidence. New recommendation*)
- In the Kingdom of Saudi Arabia (low TB incidence) adults, adolescents and children who are household contacts of people with bacteriologically confirmed PTB should be systematically tested and treated for LTBI. (*Strong recommendation, high–moderate-quality evidence. Existing recommendation*).
- All infants aged below 1 year should be given preventive treatment if they have a history of household contact with a TB case.

Other HIV-negative at-risk groups

- Patients on anti-TNF treatment, those receiving dialysis, those preparing for an organ or hematological transplant and those with silicosis should be systematically tested and treated for LTBI. (*Strong recommendation, low–very low-quality evidence. Updated recommendation*)
- In low TB incidence countries, systematic testing for and treatment of LTBI may be considered for prisoners, health workers, immigrants from countries with a high TB burden, homeless people and people who use illicit drugs. (*Conditional recommendation, low–very low-quality evidence. Existing recommendation*)
- Systematic testing for LTBI is not recommended for people with diabetes, people with harmful alcohol use, tobacco smokers and underweight people unless they are already included in the above recommendations. (*Conditional recommendation, very low-quality evidence. Existing recommendation*)

12.3. Algorithms to rule out active TB disease

Adults and adolescents living with HIV

- Adults and adolescents living with HIV should be screened for TB according to clinical algorithms. Those who do not report any of the symptoms of current cough, fever, weight loss or night sweats are unlikely to have active TB and should be offered preventive treatment, regardless of their ART status. (*Strong recommendation, moderate-quality evidence. Updated recommendation*)
- Chest radiography may be carried out in PLHIV who are on ART, and preventive treatment may be given to those with no abnormal radiographic findings. (*Conditional recommendation, low-quality evidence. New recommendation*)
- Adults and adolescents living with HIV who are screened for TB according to a clinical algorithm and who report any of the symptoms: current cough, fever, weight loss or night sweats, may have active TB and should be evaluated for TB and other diseases that cause such symptoms. (*Strong recommendation, moderate-quality evidence. Updated recommendation*)
- *Remark:* Chest radiography should not be a requirement for initiating preventive treatment.

Children living with HIV

- Infants and children living with HIV who have poor weight gain, fever or cough, or have a history of contact with a case of TB should be evaluated for TB and other diseases that cause such symptoms. If the evaluation shows no TB, these children should be offered preventive treatment, regardless of their age (See **Diagram 12.1**). (*Strong recommendation, low-quality evidence. Updated recommendation*)
- Poor weight gain is defined as a reported weight loss, very low weight-for-age (< -3 z-score), underweight (weight-for-age < -2 z-score), confirmed weight loss ($> 5\%$) since the last visit or a flattening growth curve.
- The absence of clinical symptoms of TB along with absence of abnormal chest radiographic findings may be used to rule out active TB disease among HIV-negative household contacts aged ≥ 5 years and other at-risk groups before preventive treatment. (*Conditional recommendation, very low-quality evidence. New recommendation*)
- Although LTBI testing is not a requirement for initiating preventive treatment, it may be done as a part of eligibility screening where feasible.

12.4. Testing for LTBI

- Either a TST or IGRA can be used to test for LTBI. (*Strong recommendation, very low-quality evidence. New recommendation*)
- PLHIV with a positive test for LTBI should benefit from longer preventive treatment than those with a negative LTBI test; LTBI testing can be used, where feasible, to identify such individuals. (*Strong recommendation, high-quality evidence. Existing recommendation*)
- LTBI testing by TST or IGRA is not a requirement for initiating preventive treatment in PLHIV or child household contacts aged < 5 years. (*Strong recommendation, moderate-quality evidence. Updated recommendation*)



HIV - Test

Diagram 12.1. Decision tree for preventive treatment in children aged ≥ 12 months living with HIV

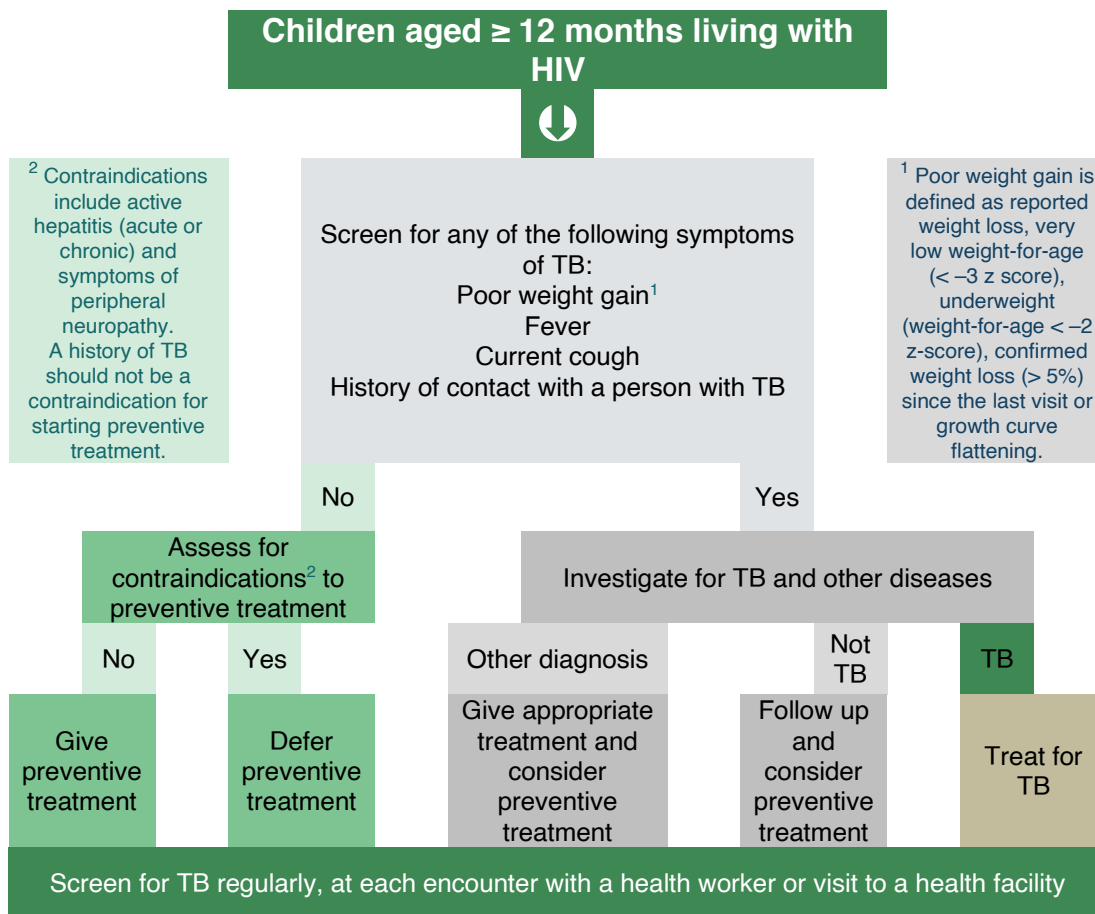

12.5. Treatment options for LTBI

- Isoniazid monotherapy for 6 months is recommended for treatment of LTBI in both adults and children in both high and low TB incidence countries. (*Strong recommendation, high-quality evidence. Existing recommendation*)
- Rifampicin plus isoniazid daily for 3 months should be offered as an alternative to 6 months of isoniazid monotherapy preventive treatment for children and adolescents aged < 15 years in high TB incidence countries. (*Strong recommendation, low-quality evidence. **New recommendation***)
- Rifapentine and isoniazid weekly for 3 months may be offered as an alternative to 6 months isoniazid monotherapy preventive treatment for both adults and children in high TB incidence countries. (*Conditional recommendation, moderate-quality evidence. **New recommendation***)
- The following options are recommended for the treatment of LTBI in low TB incidence countries, as alternatives to 6-month isoniazid monotherapy: 9-month isoniazid, or a 3-month regimen of weekly rifapentine plus isoniazid, or 3–4 months of isoniazid plus rifampicin, or 3–4 months of rifampicin alone. (*Strong recommendation, moderate–high-quality evidence. Existing recommendation*)
- In settings with high TB incidence and transmission, adults and adolescents living with HIV who have an unknown or a positive TST and are unlikely to have active TB disease should receive at least 36 months of IPT, regardless of whether they are receiving ART. IPT should also be given irrespective

of the degree of immunosuppression, history of previous TB treatment and pregnancy. (*Conditional recommendation, low-quality evidence. Existing recommendation*).

- Recommended dosages of drugs for the treatment of LTBI are presented in **table below**.

Regimen	Drug	Dose per kg Body Weight	Maximum Dose
Isoniazid alone, daily for 6 or 9 months	Isoniazid	Adults, 5 mg	300 mg
		Children, 10 mg (range, 7–15 mg)	
Daily rifampicin alone for 3–4 months	rifampicin	Adults, 10 mg	600 mg
		Children, 15 mg (range, 10–20 mg)	
Daily isoniazid plus rifampicin for 3–4 months	Isoniazid:	Adults, 5 mg Children, 10 mg (range, 7–15 mg)	300 mg
	Rifampicin:	Adults, 10 mg Children, 15 mg (range, 10–20 mg)	600 mg
Weekly rifapentine plus isoniazid for 3 months (12 doses)	Isoniazid	Individuals aged ≥ 12 years: 15 mg Individuals aged 2–11 years: 25 mg	900 mg
	Rifapentine	10.0–14.0 kg = 300 mg 14.1–25.0 kg = 450 mg 25.1–32.0 kg = 600 mg 32.1–50.0 kg = 750 mg > 50 kg = 900 mg	900 mg

12.6. Preventive treatment for contacts of patients with MDR-TB

In selected high-risk household contacts of patients with MDR-TB, preventive treatment may be considered based on personalized risk assessment and a sound clinical justification. (*Conditional recommendation, very low-quality evidence. **New recommendation***).

12.6.1. General considerations

- The preventive treatment should be given only to household contacts at high risk (e.g. children, people receiving immunosuppressive therapy and people living with HIV).
- The drugs should be selected according to the drug susceptibility profile of the source case.
- Confirmation of infection with LTBI tests is required.
- Strict clinical observation and close monitoring for the development of active TB disease for at least 2 years are required, regardless of the provision of preventive treatment.

12.6.2. Selection of drug regimen

- The regimen of preventive treatment of MDR-TB contacts should be based on reliable information on the drug resistance profile of the source case.
- Later-generation fluoroquinolones (e.g. levofloxacin and moxifloxacin) are considered to be important components of a preventive treatment regimen unless the strain of the source case is resistant to them.
- Although there has been concern about the use of fluoroquinolones in children because retardation of cartilage development was shown in animals, similar effects have not been demonstrated in humans.
- There is limited evidence for the duration of treatment, and this should be based on clinical judgement. The regimens used in the studies conducted so far were given for 6, 9 and 12 months.
- Remarks: The preventive treatment should be individualized after a careful assessment of the intensity of exposure, the certainty of the source case, reliable information on the drug resistance pattern of the source case and potential adverse events.

12.6.3. Resources and feasibility

For a programmatic approach, all the necessary resources should be in place, including for quality-assured testing for drug susceptibility, the necessary medications and a system for close monitoring of harm and adverse events. The feasibility of providing preventive treatment should be carefully assessed according to the availability of resources and the history and status of preventive treatment for drug-susceptible TB.

12.6.4. Close monitoring and treatment adherence

- Close monitoring of adverse events and adherence to treatment is essential.
- The types of adverse events depend on the drugs used.
- Reiterated strict clinical observation and close monitoring for active TB disease based on sound clinical practice and national guidelines for at least 2 years is required, regardless of the provision of preventive treatment.
- Consideration should also be given to interactions with antiretroviral, immunosuppressant and other drugs when providing MDR-TB preventive treatment.

12.7. Considerations for implementation

12.7.1. Ethical consideration

- LTBI testing and treatment raise a range of ethical issues. First, LTBI is by definition an asymptomatic state. This alters the ethical obligations that would be imposed by active TB. For example, the absence of an immediate risk of transmission makes it unethical to restrict migration on the basis of the LTBI status of an individual.
- Secondly, the difficulty of accurate assessment of individual risk for the development of active TB poses a challenge to communication.

- Informed consent requires effective, adequate communication of the uncertainty in LTBI testing, the risk for development of active TB, possible side-effects of treatment and the protective benefits. Risk and uncertainty must be communicated in culturally and linguistically appropriate forms and feedback obtained after screening programs.
- Thirdly, LTBI disproportionately affects individuals and groups that are already socially and medically vulnerable. Therefore, efforts must be made to ensure equity and human rights, so that the vulnerability of target groups does not preclude their access to screening and treatment. Any intervention for vulnerable groups should include minimization of the risk for stigmatization.
- Policies should be evaluated from an ethical perspective after implementation, both to consider possible unexpected effects and to ensure that the evidence on which they are based remains current and relevant.

12.7.2. Adverse events monitoring

- The risk for adverse events during preventive treatment must be minimized. Individuals receiving treatment for LTBI should be monitored routinely and regularly at monthly visits to health care providers. The prescribing health care provider should explain the disease process and the rationale for the treatment, and emphasize the importance of completing it.
- Adverse reactions have been associated with isoniazid (asymptomatic elevation of serum liver enzyme concentrations, peripheral neuropathy and hepatotoxicity), rifampicin and rifapentine (cutaneous reactions, hypersensitivity reactions, gastrointestinal intolerance and hepatotoxicity). While most of these reactions are minor and occur rarely, specific attention should be paid to preventing drug-induced hepatotoxicity.
- People receiving preventive treatment should be urged to contact their health care providers if they develop any symptoms between the visits, such as anorexia, nausea, vomiting, abdominal discomfort, persistent fatigue or weakness, dark-colored urine, pale stools or jaundice. If a health care provider cannot be consulted at the onset of such symptoms, the patient should immediately stop the treatment.
- Individuals receiving treatment for LTBI should be monitored routinely at monthly visits to health care providers, who should explain the disease process and the rationale of the treatment and emphasize the importance of completing it.
- There is insufficient evidence to support testing of baseline liver function. It is, however, strongly encouraged, where feasible, for individuals with the following risk factors: history of liver disease, regular use of alcohol, chronic liver disease, HIV infection, age > 35 years, pregnancy or in the immediate postpartum period (within 3 months of delivery). For individuals with abnormal baseline test results, sound clinical judgement is required to ensure that the benefit of TB preventive treatment outweighs the risks, and they should be tested routinely at subsequent visits. Appropriate laboratory testing should also be performed for patients who become symptomatic while on treatment (e.g. liver function tests for those with symptoms of hepatotoxicity).

- Individuals at risk for peripheral neuropathy, such as those with malnutrition, chronic alcohol dependence, HIV infection, renal failure or diabetes, or who are pregnant or breastfeeding, should receive vitamin B6 supplements when taking isoniazid-containing regimens.

12.7.3. Adherence and completion of preventive treatment

- Adherence to the full course and completion of treatment are important determinants of clinical benefit, both to the individual and to the success of the program. Interventions should be tailored to the specific needs of the risk groups and to the local context to ensure adherence and completion of treatment.
- Interventions to ensure adherence and completion of treatment should be tailored to the specific needs of risk groups and the local context.
- The WHO guidelines for treatment of drug-susceptible active TB propose several interventions to support adherence, which could be applied to treatment of LTBI.
- Fixed-dose combinations such as isoniazid plus rifampicin should be used where possible to reduce the number of pills to be taken.
- Concerns about adherence should not be a barrier to use of preventive treatment.

12.7.4. Drug resistance and surveillance

- There is no evidence of a significant association between bacterial resistance to TB drugs and use of isoniazid or rifampicin for the treatment of LTBI.
- Nonetheless, active TB disease must be excluded before TB preventive treatment is initiated (see above), and regular follow-up is required to ensure early identification of people who develop active TB while receiving TB preventive treatment.
- National surveillance systems for resistance to TB drugs should be established in countries implementing programmatic management of LTBI.

12.7.5. Interactions with antiretroviral drugs

- Regimens containing rifampicin and rifapentine should be prescribed with caution to PLHIV who are on ART because of potential drug–drug interactions. These regimens should not be administered to people receiving protease inhibitors or nevirapine.
- The 3-month regimen of weekly rifapentine plus isoniazid can be administered to patients receiving efavirenz-based antiretroviral regimens without dose adjustment, according to a study of pharmacokinetics.
- Administration of rifapentine with raltegravir was found to be safe and well tolerated.
- Rifapentine-containing regimens should not be administered with dolutegravir until more information becomes available.
- There is urgent need for studies of the pharmacokinetics of the 3-month regimen of weekly rifapentine plus isoniazid concomitantly with other drugs, particularly ART.

12.8. Program management, monitoring and evaluation

- Programmatic management of LTBI should include monitoring and evaluation systems that are aligned with national patient monitoring and surveillance systems. Appropriate recording and reporting tools should be developed, and standardized indicators (Table 12.1) should be measured to regularly inform decision-making for program implementation.
- The national TB program should prepare a national plan for programmatic management of LTBI, including prioritizing groups identified as being at high risk on the basis of local epidemiology and the health system.
- Regional TB program should prepare a plan for programmatic LTBI management, including prioritization of groups at high risk on the basis of local epidemiology and the characteristics of the health system.
- This should include promoting universal health coverage and offering public financing for LTBI management. Furthermore, dedicated resources should be allocated, including for human resource development and service delivery in the community.
- The program is also encouraged to ensure access to comprehensive care for co-existing risk factors for TB, such as diabetes, undernutrition and tobacco smoking.
- Preventive TB treatment for PLHIV should be a core component of HIV preventive care and should be the responsibility of national AIDS program and HIV service providers. Preventive treatment should not be viewed as an isolated intervention but should be part of a comprehensive package of care.
- Coverage of contact investigation and treatment of LTBI among child contacts and PLHIV are among the top 10 core indicators for monitoring implementation of the End-TB Strategy.
- It is important to engage the private health sector and to ensure proper recording and reporting from both the private and public sectors.

Table 3: Monitoring and evaluation indicators for programmatic management of LTBI recommended by WHO

#	INDICATOR	NUMERATOR	DENOMINATOR	PURPOSE
1	Proportion of children < 5 years who are household contacts of TB cases (according to national guidelines) who have completed investigations for TB	Total number of children < 5 years who are household contacts of TB cases who completed investigations for TB (according to national guidelines) during the reporting period	Total number of children < 5 years who were household contacts of TB cases (according to national guidelines) during the reporting period	Measures the capacity of the program to ensure effective contact investigation, a key component of TB diagnosis and prevention among children < 5 years
2	Proportion of children < 5 years old who are household contacts of TB cases (according to national guidelines) who are eligible for TB preventive treatment who have started treatment	Total number of children < 5 years who are household contacts of TB cases who started TB preventive treatment during the reporting period	Total number of children < 5 years who are household contacts of TB cases who were eligible for TB preventive treatment during the reporting period	Measures the capacity of the program to initiate treatment in children < 5 years who are household contacts and are eligible for TB preventive treatment
3	Proportion of eligible people living with HIV, newly enrolled in HIV care and started on TB preventive treatment	Total number of eligible people living with HIV who started TB preventive treatment during the reporting period	Total number of eligible people living with HIV and newly enrolled in HIV care during the reporting period	Measures the capacity of the program to initiate treatment of all individuals in HIV care who are eligible for TB preventive treatment
4	Proportion of eligible individuals in at-risk populations (as defined by national guidelines) tested for LTBI infection	Total number of individuals in at-risk populations who were tested for LTBI during the reporting period	Total number of individuals in at-risk populations who were eligible for testing during the reporting period	Measures coverage of testing at-risk populations eligible for TB preventive treatment
5	Proportion of individuals in at-risk populations (according to national guidelines) with a positive LTBI test who are eligible for TB preventive treatment and who have started treatment	Total number of individuals in at-risk populations who started TB preventive treatment during the reporting period	Total number of individuals in at-risk populations who have tested positive for LTBI and were eligible for TB preventive treatment during the reporting period	Measures the capacity of the program to initiate treatment of individuals in at-risk populations who are eligible for TB preventive treatment
6	Proportion of eligible individuals in at-risk populations (according to national guidelines) with a positive LTBI test who started TB preventive treatment and completed the course	Number of individuals in at-risk populations who completed the course of TB preventive treatment during the reporting period	Total number of individuals in at-risk populations with a positive LTBI test who started TB preventive treatment during the reporting period	Measures the capacity of the program to ensure that individuals in at-risk populations adhere to the full course of treatment
7	Proportion of eligible people living with HIV who completed a course of TB preventive treatment	Number of eligible people living with HIV who completed a course of TB preventive treatment during the reporting period	Total number of eligible people living with HIV who started TB preventive treatment during the reporting period	Measures the capacity of the program to ensure that people living with HIV adhere to the full course of treatment

8	Proportion of children < 5 years who are household contacts of TB cases (according to national guidelines) who have completed a course of TB preventive treatment	Number of children < 5 years who are household contacts of TB cases (according to national guidelines) who completed a course of TB preventive treatment during the reporting period	Total number of children < 5 years who are household contacts of TB cases (according to national guidelines) who started TB preventive treatment during the reporting period	Measures the capacity of the program to ensure that children < 5 years who are household contacts of TB cases adhere to the full course of treatment
9	TB incidence rate in at-risk populations (as defined by national guidelines)	Total number of newly notified TB cases in at-risk populations during the reporting period	Total number of individuals in at-risk populations	Measures the impact of the program on the incidence of TB in at-risk populations

Reference

Latent tuberculosis infection Updated and consolidated guidelines for programmatic management 2018. Available at : <https://apps.who.int/iris/bitstream/handle/10665/260233/9789241550239-eng.pdf?sequence=1>

13. Tuberculin Testing

13.1. Background

The tuberculin skin test (TST) is one of the few investigations dating from the 19th century that are still widely used to test for tuberculosis infection. It is a strategic component of NTP that identifies persons at high risk for developing TB, who should benefit from treatment for LTBI, if detected.

The test consists of the administration of tuberculin via intra-dermal route. The most widely used tuberculin is the purified protein derivative (PPD), which is derived from cultures of *M. tuberculosis*. The “old tuberculin” is no longer used for this purpose, as it contains impurities with varying composition from one batch to another, which poses a problem when comparing results. A more standardized product called PPD-S (purified protein derivative), prepared according to the method described by Siebert, from *M. tuberculosis* is used. Other formulations of PPD are identified such as PPD-RT21, PPD-RT23, and PPD-CT68. PPD-RT 23 (Research Tuberculin) is the recommended formulation by WHO and the most commonly used worldwide.

The reaction to intradermal injected tuberculin is the classic example of a delayed (cellular) hypersensitivity reaction. T-cells sensitized by prior infection are recruited to the skin site where they release lymphokines. These lymphokines induce induration through local vasodilatation, edema, fibrin deposition, and recruitment of other inflammatory cells to the area. Features of the reaction include: delayed course reaching a peak more than 24 h after injection of the antigen, indurated character and occasional vesiculation and necrosis.

13.2. Storage precautions for PDD antigen

- Date each PPD vial when opened.
- Keep PPD vials refrigerated at all times or in a cooler with ice packs.
- Keep PPD vials protected from light. If the vial is exposed to light for extended or unknown period of time, it should be discarded.
- If PPD vial is accidentally frozen, it should be discarded.
- When a vial must be discarded, discard it following local health department protocol.

13.3. Test standardization

- The first tuberculin used (referred to as “old tuberculin”) contained impurities and their composition varied from one batch to another, which posed a problem when comparing results.
- In 1934, Seibert prepared a purified protein derivative (PPD).
- In 1951, this PPD was adopted by WHO as the international standard, and the designation PPD-S was used.
- Other formulations of PPD are identified such as PPD-RT21, PPD-RT23, and PPD-CT68.
- All commercial PPD formulations must be standardized with respect to PPD-S.
- PPD-RT23 is the most commonly used formulation worldwide, and the one recommended by the WHO.

- 2 TU of PPD-RT23 strain is equivalent to 5 TU of PPD-S.

13.4. Indications

13.4.1. Individual with increased risk for new infection: (all patients should be tested regardless of age).

- Close contacts of persons with active PTB.
- Persons who live or work in clinical or institutional settings with risk of exposure to TB (e.g., hospitals, prisons, nursing homes, microbiology labs).

13.4.2. Individuals with clinical conditions associated with increased risk of TB reactivation

High risk (all patients should be tested regardless of age)

- Persons with HIV infection.
- Persons who never received antituberculosis therapy with abnormal chest x-ray including apical fibronodular changes typical of healed TB (not including granuloma)
- Persons with certain medical conditions such as silicosis, chronic renal failure on dialysis, transplant, lymphoma, leukemia chemotherapy.

Moderate risk (only patients less than 65 years of age should be tested).

- Diabetes mellitus
- Persons receiving immunosuppressive therapy (e.g., prolonged corticosteroid therapy [the equivalent of >15 mg/day of prednisone for one month or more], TNF- α blockers, etc.)

13.5. Patient interview

The patient should be interviewed regarding the following:

- TB exposure history
- Identifiable risk factor(s) for TB infection
- Previous TST reactions
- Recent live virus immunizations (e.g. measles, mumps, rubella, varicella, yellow fever, or MMR)
- History of BCG and Allergies.

Explain the following to the patient:

- TB transmission, diagnosis and treatment.
- Mantoux skin testing procedure.
- Two-step testing is indicated for all health care providers (refer to 12.9).
- The connection between TB and HIV/AIDS.
- Importance of follow-up visit - provide the client with a written return date.
- Provide the client with TB educational materials.

13.6. Administration (Mantoux test)

13.6.1. Administration precautions for PPD antigen

- Do not draw PPD antigen into syringes until ready to administer.
- Never transfer PPD from one vial to another vial.
- Avoid administering PPD antigen to documented positive TST individuals as the severity of the reaction may increase.
- Avoid injecting PPD antigen subcutaneously. A general febrile reaction or acute inflammation around prior TB lesions may occur.
- If a live virus vaccine, especially measles, yellow fever, varicella, or measles, mumps, rubella (MMR), was administered before the TST, a waiting period of six weeks should be observed before the TST is administered, as a false reaction may occur. A live virus vaccine may be administered either at the time of TST administration or after interpretation.
- See PPD antigen insert or the current Physician's Desk Reference for additional information.

13.6.2. Dose and administration

The standard method for TST administration that has been recommended by WHO is the Mantoux test.

- Use a disposable 1.0 ml graduated syringe fitted with a short bevel needle, 25-26 gauge.
- Fill the syringe immediately before use.
- Draw up slightly more than 0.1 ml of PPD, remove any bubbles and reduce the volume to exactly 0.1 ml

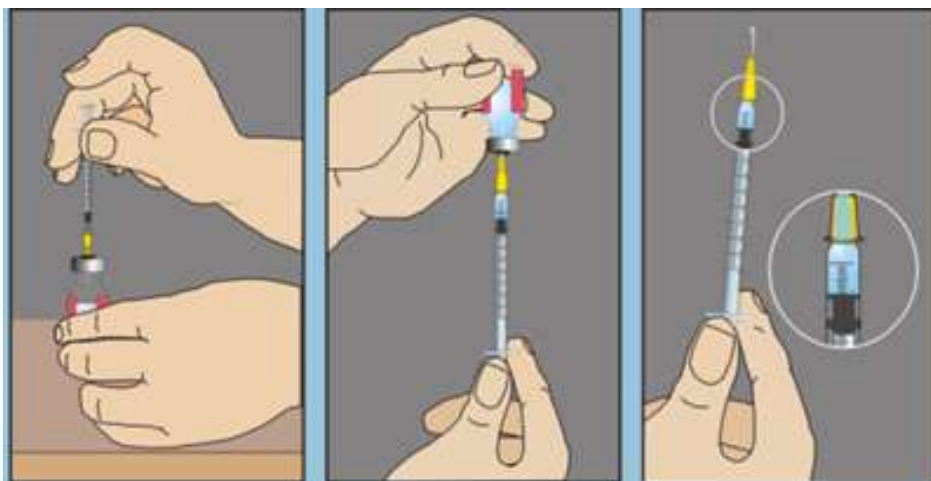

The test is performed on the frontal side of the forearm, and the needle should be inserted into the superficial layer of the skin.

- Slightly pull down the skin in the direction of the needle and parallel to the forearm.
- Penetrate the skin with the bevel up entering the most superficial layer of the skin; the needle should be visible through the dermis during injection.
- Inject the solution slowly.
- A small papule of 8-10 mm diameter will appear and remain for about 10 minutes.
- If no papule is formed, the solution might have been injected too deeply and the test should be repeated at another site, at least 5 cm away from the first site.
- After administering the TST, advise the patient not to rub or scratch the test site.
- Give the client a cotton ball to dab the area lightly and to wipe off any drops of blood, which may occur.
- Do not put a band-aid on the test site.
- Document the test site in the patient's record.



13.7. Reading tuberculin test results (Mantoux test):

- Read the reaction after 48-72 hours of performing the test. Only the diameter of the skin induration has to be measured, in millimeters, using a little transparent ruler scaled into millimeters.
- Induration (raised area) should be palpated and inspected in both direct and indirect lighting. The diameter of the induration is measured transversely to the long axis of the arm and recorded in millimeters (mm).
- If there is no induration at all the result of measurement will be zero.
- Erythema (redness) should not be included in the measurement.
- The test report should include the following: type of tuberculin used, dose administered, the administration technique and the detected induration in mm (example: Tuberculin skin test performed with 2 TU of PPD-RT23, revealing an induration of 12 mm after 72 hours).



13.8. Interpretation of the Mantoux TST Results

Skin test interpretation depends on both the measurement, in millimeters, of the induration and the person's risk of being infected with TB and/or progressing to disease if infected.

13.8.1. Positivity criteria

The following three cut points should be used to determine whether the skin test reaction is *positive*. A measurement of 0 mm or anything below the defined cut off point for each category is considered *negative*.

Interpretation of a positive result should be done according to the criteria defined in the table below.

TST Result (induration diameter, in mm)	Positivity criteria (conditions where the result should be considered positive)
≥5 mm	<ul style="list-style-type: none"> ▪ HIV-positive persons ▪ Recent contacts of TB case ▪ Persons with fibrotic changes on chest radiograph consistent with old healed TB ▪ Patients with organ transplants ▪ Other immunosuppressed patients for any reason
≥10 mm	<ul style="list-style-type: none"> ▪ Recent arrivals from high-prevalence countries ▪ Injectable drugs users ▪ Residents and employees of high-risk congregate settings ▪ Mycobacteriology laboratory personnel ▪ Persons with clinical conditions that place them at high risk (e.g. silicosis, chronic renal failure on dialysis - transplant, lymphoma, leukemia chemotherapy). ▪ Children <4 years of age, or children and adolescents exposed to adults in high-risk categories.
≥15 mm	<ul style="list-style-type: none"> ▪ Persons with no known risk factors for TB

13.8.2. Causes of false negative results

The reaction could be negative despite the presence of tuberculosis infection in the following conditions:

Factors related to the person subjected to the test

- Recent live virus vaccination
- Anergy, which is defined as non-responsiveness to delayed-type antigen-induced hypersensitivity. It may be observed among persons with impaired immune system (e.g., persons infected with HIV).
- Other viral infections: measles, parotitis, varicella
- Therapeutic immunosuppression
- Chronic renal failure
- Recent TB infection
- Severe TB disease
- Leukemia, lymphoma, Hodgkin's disease

- Sarcoidosis
- High fever of any origin
- Newborn infants (< 6 months old) or advanced age
- Stress, surgery, burns, mental disorders
- Malnutrition

Factors related to the tuberculin used

- Inappropriate storage (exposure to heat or light)
- Inappropriate dilutions
- Chemical denaturalization
- Adsorption by the container (partially controlled by Tween 80 detergent).

Factors related to the method of administration

- Administration of too little antigen
- Subcutaneous injection
- Delay in administration after extracting the dose from the container
- Injection too close to other antigens

Factors related to registry of the result

- Reader inexperience
- Errors

13.8.3. Causes of false positive

- Non-tuberculous mycobacteria
- BCG vaccination: most of the international guidelines recommend ignoring BCG's effect in the interpretation of TST in persons at increased risk of developing active TB. Also, history of BCG vaccination is not a contraindication for TST.
- Boosting effect: some people with TB infection may have a negative TST reaction when tested many years after their initial infection. However, this initial skin test may stimulate ("boost") their ability to react to tuberculin antigen in repeat tests. Positive reactions to the repeat tests may be misinterpreted as new infection. To overcome this boosting effect, a two-steps testing is recommended.

13.9. Two-step testing

13.9.1. Indications

Two-step testing is recommended for the initial skin testing of adults in the following situations:

- Adults with no documented history of negative TST within the past 12 months.
- Adults who will be retested periodically, such as health care staff, residents in jails, etc.
- Certain populations, such as new nursing home residents.

13.9.2. Procedure

- For persons who test negative to the first TST, a second test should be administered within one to three weeks after the first test and read 48 to 72 hours after application.
- If the second TST is positive, this probably represents a “boosted” reaction of a remote infection and may not be due to a recent infection.
- If the second TST is negative, the client should be considered not infected.

13.10. Referral

- Individuals with positive, well-conducted TST should receive further evaluation to rule out the presence of TB disease.
- Additional follow-up should be performed to identify potential candidates for treatment of latent TB infection (See Chapter 12).

14. Contact Screening

14.1. Definitions

Index case (index patient)	The initially identified case of new or recurrent TB in a person of any age in a specific household or other comparable setting in which others may have been exposed
	An index case is the case around which a contact investigation is centred. Because the investigation generally focuses on a defined group of potentially exposed people, among whom other (secondary) cases may be found, the index case is generally the case identified initially, although she or he may not be the source case. Contact investigation may be centered on secondary cases if the exposed group differs from that exposed to the original index case.
Contact	Any person who has been exposed to an index case (as defined above)
	Exposure may be intense or casual, easily identified or obscure. Close exposure, such as sharing a living or working space, is generally easily identified and quantified, whereas casual exposure, such as on public transport or in social situations, may remain unidentified.
Household Contact	A person who shared the same enclosed living space for one or more nights or for frequent or extended daily periods with the index case during the 3 months before commencement of the current treatment episode.
	Definitions of 'household' vary considerably and must be adapted to the local context. Within households, there is a gradation of exposure, ranging from sharing the same bed as the index case to living in the same compound but not in the same enclosed space. Quantification of the amount of exposure, estimated as the time spent with the index case, may be highly subjective. For this reason, the infectious period for the index case is set somewhat arbitrarily at 3 months before initiation of treatment rather than relying on recall by the index case of the time when symptoms began. The 3-month period is a general guideline; the actual period of infectiousness may be longer or shorter. For example, prolonged infectiousness may be associated with nonadherence (if directly observed treatment is not being used) or with unrecognized or untreated MDR-TB or XDR-TB.
Close Contact	A person who is not in the household but shared an enclosed space, such as a social gathering place, workplace or facility, for extended daily periods with the index case, during the 3 months before commencement of the current treatment episode.
	Out-of-household exposure is as likely to result in transmission as household exposure in many situations. Such sites (particularly social settings) are difficult to identify and require knowledge of the culture and behavioral patterns in order to focus contact investigations.
Contact investigation	A systematic process intended to identify previously undiagnosed cases of TB among the contacts of an index case. In some settings, the goal also includes testing for LTBI to identify possible candidates for preventive treatment. Contact investigation consists of two components: identification & prioritization, and clinical evaluation.
	The rationale for contact investigation is that people who were recently infected with <i>M. tuberculosis</i> are at increased risk for the development of active TB within 1–2 years, after contamination. It is assumed that people who have been exposed to a person with infectious TB might be currently having TB infection with increased risk of developing the disease in the near future.
Contact identification and prioritization	A systematic process to identify contacts with TB or at increased risk for development of TB. For the purposes of these recommendations, the definition of contact identification and prioritization includes an interview with the index case to obtain the names and ages of contacts and an assessment of contacts' risk for having or developing TB (generally based on the presence of symptoms compatible with TB), to determine those for whom clinical evaluation (defined below) is indicated.
	At a minimum, all index cases should be assessed with the above criteria to determine whether contact investigation should be undertaken. For example, contact investigation would not usually be conducted for an index case with only extrapulmonary TB, except for children < 5 years of age, in whom investigations would be undertaken in an attempt to identify the source case.
Contact clinical evaluation	A systematic process for the diagnosis or exclusion of active TB among contacts. Clinical evaluation is undertaken if the results of contact identification and prioritization indicate a risk for having or developing TB. For the purposes of these recommendations, the definition of contact clinical evaluation includes, at a minimum, a more extensive assessment of symptoms compatible with TB. Additional components may include: a more detailed medical history, a physical examination, microbiological assessment of specimens from sites of suspected involvement, radiographic examinations and invasive diagnostic tests. Implementation of these components will depend on the clinical circumstances and the available resources. In addition, depending on the epidemiological circumstances and resources, a tuberculin skin test or an interferon gamma release assay for LTBI may be part of the clinical evaluation.
	The goal of contact investigation is to find previously undiagnosed cases of active TB. The goal of clinical evaluation is to diagnose or exclude TB and, in some situations, to identify and possibly treat LTBI. The approaches used depend on resources and circumstances; however, in all situations, contacts should be interviewed to determine whether they have symptoms consistent with TB, and they should be further evaluated if symptoms are present

14.2. Recommendations

- 1 It is recommended that contact investigation be conducted for household and close contacts when the index case has any of the following characteristics:
- 2 Sputum smear-positive PTB,
- 3 MDR-TB or XDR-TB (proven or suspected),
- 4 is a PLHIV or
- 5 is a child < 5 years of age.
- 6 Information that is essential for determining the potential risk posed by the index case includes:
 - The results of sputum smears or other microbiological evaluations;
 - Radiographic features of the disease (if available);
 - The severity, type and duration of symptoms (especially cough)
 - The presence of risk factors for drug resistance;
 - Known or presumed HIV infection
 - The setting in which exposure occurred
- 7 In settings of high HIV prevalence, it is recommended that all household and close contacts be counselled and tested for HIV.
- 8 It is recommended that all household and close contacts of people with TB who have symptoms compatible with active TB should receive counselling and testing for HIV as part of their clinical evaluation.
- 9 PLHIV who are household or close contacts of people with TB and who, after an appropriate clinical evaluation, are found not to have active TB should be treated for presumed LTBI.
- 10 Children < 5 years of age who are household or close contacts of people with TB and who, after an appropriate clinical evaluation, are found not to have active TB should be treated for presumed LTBI.

14.3. Timing for interviews and identification of Contacts

- Contact investigation, by interviewing the index case, should be initiated as soon as possible after diagnosis (generally within 1 week) to elicit the names of household and close contacts.
- Initial focus should be on household members, but people in the workplace and other settings in which there is exposure should not be ignored.
- Contacts in residential care facilities, long-term care facilities, jails and prisons and acute medical care facilities, especially when exposure is by coughing, should be evaluated.
- Ideally, the interview should be conducted by a person who speaks the same language as the index patient and is familiar with his or her social and cultural context.
- Investigations should be conducted even for patients who have died, by gathering information from the family members whenever possible.

- A sense of urgency should be conveyed in contact investigations, including prompt interviewing of the index case.
- Occasionally, a second interview is useful to elicit additional contacts.
- Information collected from the interview should be recorded on standardized forms.

14.4. Instigation of a Contact investigation

Contact investigation should be triggered as soon as possible, as a result of:

- Notification that a respiratory specimen laboratory result is bacteriologically confirmed by microscopy, culture or Xpert-MTB for *Mycobacterium tuberculosis* (MTB).
- Notification that a negative respiratory smear result becomes culture positive and/or Xpert-MTB positive for *Mycobacterium tuberculosis*.
- If AFB are not detected by microscopy of three sputum smears, an investigation is still recommended if the chest radiograph indicates the presence of cavities in the lung.
- Active tuberculosis in young children is rarely infectious, but it is usually a sign of a recent infection. Reverse contact investigation of the child's close contacts should be done to identify the source case.
- A clinical diagnosis of active TB in the absence of laboratory confirmation should be discussed with TB Control to determine the need for contact investigation.
- Non-pulmonary TB cases may require contact tracing (especially in laryngeal TB) and should be discussed with TB Control.

14.5. Factors that increase likelihood of TB transmission

14.5.1. Sputum Bacteriology

Infectiousness is highest when sputum is positive by smear microscopy or culture. Other respiratory specimens (e.g., bronchial washings or bronchoalveolar lavage fluid) have to be regarded as equivalent to Sputum.

14.5.2. Radiographic Findings

Patients who have lung cavities observed on a chest radiograph are more infectious than patients with non-cavitary pulmonary disease.

14.5.3. Behaviors that increase aerosolization of respiratory secretions

Cough frequency and severity are not predictive of contagiousness; however, singing is associated with TB transmission. Sociability of the index patient might contribute to contagiousness because of the increased number of contacts and the intensity of exposure.

14.5.4. Administration of effective treatment

Patients under proper anti-TB drugs become less contagious within few days to two weeks of starting treatment. Those who are not under treatment or showing non-response are more contagious.

14.6. Procedures for Contact investigation

14.6.1. Collect Data related to the index case

Review the patient's file, meet the physician and the infection control personnel to collect the required data including residence, employment, first language, given name and street names, aliases, date of birth, telephone numbers, other electronic links, and next-of-kin or emergency connections, besides other demographic data.

14.6.2. Assess the index case and decide whether to initiate contact investigation

Initiation of contact investigation should be based on the evaluation of the infectiousness of the index case.

14.6.3. Determining the infectious Period

Determining the infectious period focuses the investigation on contacts who are most likely to be at risk for infection and sets the timeframe for testing contacts. Individuals who were in contact with patient 3 months before symptom onset or first positive finding should be included in the investigation.

14.6.4. Make an interview with the index case to obtain the following data:

- The interview should be conducted <1 business day of reporting for infectious persons and <3 business days for others to locate the contact residence and collect data that could facilitate contact listing and evaluation.
- The interview should be conducted face to face in the hospital, TB clinic, patient's home, or any convenient location that accommodates the patient's right to privacy.
- The patient should be reassured regarding social stresses related to the illness and oriented to the contact investigation.
- Interviewing skills are crucial to establish a good relation with the patient. Establishing respect is critical to build this relation.
- The interviewer should display official identification and explain the reasons for the interview.
- The interviewer should also discuss confidentiality and privacy in frank terms that help the patient decide how to share information.
- Sufficient time should be allocated for a two-way exchange of information.

14.6.5. Field visit

Site visits are complementary to interviewing. They add contacts to the list and are the most reliable source of information regarding transmission settings (evaluating the environment). Visiting the index patient's residence is especially helpful for finding children who are contacts and to search for the index cases for those children. The visit should be made <3 days of the initial interview.

14.6.6. List the contacts with the required data in the contact register adopted by NTP

Contact register is an official data collection form kept at health facilities investigating contacts of TB patients. It includes data related to the index case and his/her contacts in a form of line listing.

14.6.7. Refer contacts to be investigated for TB

- Official referral form has to be used.
- The facility to which the contacts are referred should give feedback to the referring facility.
- The referring facility should follow and ensure that referred contacts are evaluated

14.6.8. Investigate contacts

Contacts have to be investigated using the following methods:

Detailed medical history including

- Previous M. tuberculosis infection or disease and related treatment.
- Results of previous TST.
- Current symptoms of TB illness (e.g., cough, chest pain, hemoptysis, fever, chills, night sweats, appetite loss, weight loss, malaise, or easy fatigability).
- Medical conditions or risk factors making TB disease more likely (e.g., HIV infection, intravenous drug use, diabetes mellitus, silicosis, prolonged corticosteroid therapy, other immunosuppressive therapy, head or neck cancer, hematological and reticuloendothelial diseases, end-stage renal disease, intestinal bypass or gastrectomy, chronic malabsorption syndrome, or low body weight).
- Mental health disorders (e.g., psychiatric illnesses and substance abuse disorders).
- Type, duration, and intensity of TB exposure.
- Sociodemographic factors (e.g., age, race or ethnicity, residence, and country of birth).
- Contacts who do not know their HIV-infection status should be offered HIV counselling and testing.

Physical examination

Investigations

- TST has to be performed and interpreted as mentioned in the section of tuberculin testing (Chapter 13).
- If TST is positive, chest radiography has to be performed.
- If chest radiography shows abnormal findings or the patient has suggestive symptoms, sputum smear microscopy or Xpert MTB/rif should be done.
- Other invasive diagnostic tests may be needed.

14.6.9. Monitoring and evaluation

Data from the contact investigation should be collected in a standardized format.

TB control programs should routinely evaluate the effectiveness of contact investigations and design interventions to improve performance.

The yield of contact investigations and the incidence of active TB and LTBI should be evaluated to determine whether the intervention is giving the desired results.

At a minimum, the following information should be collected: number of contact investigations carried out; age (especially children < 5 years of age); sex and HIV status of the contacts identified; the number who completed medical evaluation and relevant investigations; the number with active TB; and the numbers of children < 5 years of age and PLHIV given isoniazid preventive treatment.

Data collection during contact investigations has multiple purposes:

- First, good information is important for the management and follow-up of index cases and their contacts.
- Secondly, systematic collection of data will enable analyses of the yield of contact investigations overall and for specific groups and epidemiological settings.
- Thirdly, data on indicators of care are useful for evaluating program performance objectives. Data collection and storage require significant work; an investment must be made in designing data collection tools and setting up protocols for the collection, entry and analysis of data. If data are collected but not analyzed and used to guide the program, the effort is wasted.

Diagram 13.1. Procedures for contact investigation

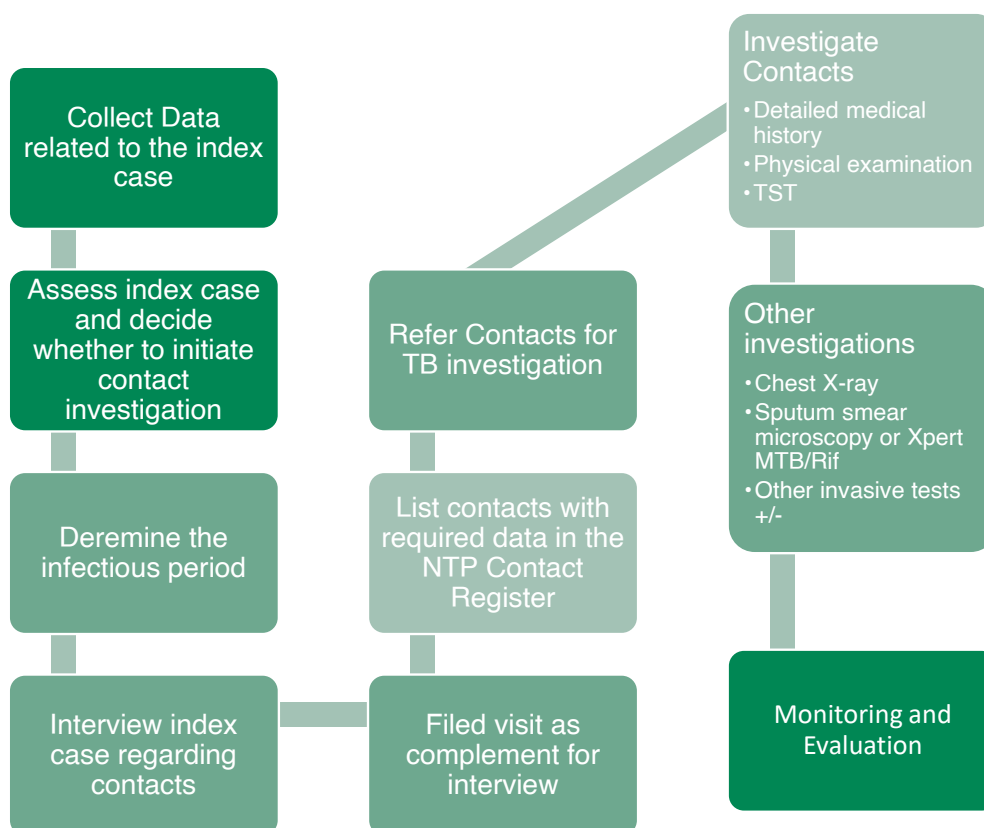

Reference

World Health Organization. Recommendations for investigating contacts of persons with infectious tuberculosis in low-and middle-income countries.

15. Preventive Measures of Tuberculosis

15.1. Background

The best way to prevent TB is to provide effective treatment to infectious TB patients. By doing so, the chain of transmission is interrupted. In addition to treatment of infectious cases, protection against exposure for mycobacteria is an essential element to reduce infection.

All health-care settings need an infection-control program designed to ensure the following:

- Prompt detection of infectious patients;
- Airborne precautions; and
- Treatment of people who have suspected or confirmed TB disease.

In all health-care settings, particularly those receiving persons at high risk for exposure to *M. tuberculosis*, either to work or to receive care, policies and procedures for TB control should be developed, reviewed periodically, and evaluated for effectiveness to determine the actions necessary to minimize the risk for transmission of *M. tuberculosis*.

15.2. TB Infection-Control Measures

The TB infection-control program should be based on a three-level hierarchy of control measures and include:

15.2.1. Administrative controls

Administrative measures are intended primarily to reduce the risk of uninfected people being exposed to people who have TB disease. These control measures include the following activities:

- Assigning responsibility for TB infection control in the facility.
- Conducting a TB risk assessment of the facility.
- Developing and instituting a written TB infection-control plan to ensure prompt detection, airborne precautions, and treatment of persons who have suspected or confirmed TB disease.
- Implement a TB screening protocol for patients presenting with cough or other respiratory symptoms. A screening tool should determine the presence of any one of the following: duration of cough for more than three weeks, blood in sputum, night sweats, unexplained weight loss, and history of TB disease or TB exposure.
- If screening results increase suspicion of TB, ask the patient to wear a surgical mask and place in a private examination room or remove from others immediately.
- All staff members entering the examination room should wear a NIOSH approved fit-tested N-95 respirator.
- Once the room is empty, it should remain unoccupied for a period of time to clear the air of airborne TB particles.

- Do not perform aerosol inducing procedures or sputum collections in public health facilities, as negative pressure rooms are usually not available to contain airborne particles generated by these procedures.
- Ensuring the timely availability of recommended laboratory processing, testing, and reporting of results to the ordering physician.
- Implementing effective work practices for the management of patients with suspected or confirmed TB disease.
- Ensuring proper cleaning and sterilization or disinfection of potentially contaminated equipment (e.g., bronchoscopes, endoscopes).
- Provide tissue, hand hygiene products, and waste containers in common areas, such as waiting rooms, so persons with respiratory symptoms can contain coughing and sneezing.
- Have surgical masks available for persons to wear while waiting.
- Place persons with respiratory symptoms in an examination room or area away from others as soon as possible.
- Display posters and other educational material to encourage cough etiquette practices.
- Consider use of barriers such as Plexiglas “sneeze guards” for reception areas.
- Training and educating healthcare workers regarding TB, with specific focus on prevention, transmission, and symptoms.
- Screening and evaluating healthcare workers who are at risk for TB disease and who might be exposed to *M. tuberculosis*.

15.2.2. Environmental measures

The aim of environmental measures is to prevent the spread and reduce the concentration of infectious droplet nuclei in ambient air.

Using local exhaust ventilation (hoods, tents, or booths) should be considered to:

- Dilute and remove contaminated air to control the source of infection.
- Control the airflow to prevent contamination of air in areas adjacent to the source of infection and clean the air by using high efficiency particulate air (HEPA) filtration, or ultraviolet germicidal irradiation.

15.2.3. Use of personal protective equipment

The above two control measures minimize the number of contaminated areas in the health-care facility but do not eliminate the risk of exposure to *M. tuberculosis*. Therefore, the use of respiratory protective equipment in situations that pose a high risk of exposure to *M. tuberculosis* is recommended.

Use of respiratory protection equipment can further reduce the risk for exposure of healthcare workers to infectious droplet nuclei that have been expelled into the air from a patient with infectious TB disease. The following measures can be taken to reduce this risk:

- Implementing a respiratory protection program.
- Training healthcare workers on respiratory protection.
- Training patients on respiratory hygiene and cough etiquette procedures. Cough etiquette, is a simple, inexpensive and effective method of preventing transmission of *M. tuberculosis*. The patient must use handkerchiefs held closely to the face, covering the mouth and nose during every cough and sneeze to prevent aerosol formation. This technique should be a topic of health education.

15.3. Determining the Infectiousness of TB Patients

- In general, patients who have suspected or confirmed TB disease should be considered infectious if:
 - They are coughing, undergoing cough-inducing procedures, or have positive sputum smear results; or
 - They are not receiving adequate anti-TB therapy, have just started therapy, or have a poor clinical or bacteriologic response to therapy.
- For patients placed under airborne precautions because of suspected infectious TB disease of the lungs, airway, or larynx, airborne precautions can be discontinued in the following situations:
 - Another diagnosis is made that explains the clinical syndrome; or
 - The patient produces three consecutive negative sputum smears collected in 8 to 24-hour intervals (one should be an early morning specimen).
- Patients who have drug-susceptible TB of the lung, airway, or larynx, should remain under airborne precautions until they:
 - Produce three consecutive negative sputum smears collected in 8 to 24-hour intervals (one should be an early morning specimen)
 - Receive at least 2 weeks of standard multidrug anti-TB treatment; and
 - Show clinical improvement

15.4. NTP recommendations for protection against exposure to TB

The following recommendations should be taken into account:

- Hospitalize patients with smear-positive PTB for the intensive phase of anti-TB treatment, if necessary.
- Patients should be isolated to reduce the risk of TB exposure to other patients.
- Patients in isolation should not visit wards or public areas of the hospital and should not be transported through open wards unless they are wearing masks.
- Only patients with TB diagnosis should be admitted to the TB ward.
- It is particularly important to avoid exposure to TB in TB suspects with HIV infection because of the high susceptibility to infection with *M. tuberculosis*.
- Patients with suspected or confirmed pulmonary TB should not be admitted to a ward containing severely immunocompromised patients, such as HIV-infected, transplant or oncology patients.

16. Health Education

16.1. Background

Health education is any combination of learning experiences designed to help individuals and communities improve their health by increasing their knowledge or influencing their attitudes.

Health promotion is defined as “*the process of enabling people to increase control over and to improve their health.*”

16.2. Framework

Health education is considered one of the main pillars of the NTP. It should be planned and implemented in collaboration with specialized directorates and personnel in the field of health education. The main aspects of health education in TB are presented in the following flowchart (**Box 16.1**).

16.3. Instruction for tuberculosis patients

- Tuberculosis is transmitted by exposure to an infectious TB patient through respiratory system (coughing, sneezing and shouting).
- Symptoms of tuberculosis include continuous cough for more than three weeks, fever, night sweating and loss of appetite and weight.
- Tuberculosis is becoming now a curable disease if prescribed drugs are taken regularly for the recommended duration under medical supervision. Consequently, tuberculosis is no longer considered a non-curable disease but a curable one, subject to respecting some instructions (**Box 16.2**).

Box 16.1. Framework of TB-related Health Education in the Kingdom of Saudi Arabia

Vision	To free the Kingdom of communicable diseases of tuberculosis.
Missions	<ul style="list-style-type: none"> ▪ To eliminate TB disease through early detection of cases, ▪ To provide treatment and proper follow up for patients, ▪ To provide prophylaxis for contacts, and ▪ To prevent transmission of the disease in the community
Objective	<ul style="list-style-type: none"> ▪ Encouraging patients to seek and adhere to treatment, until cure. ▪ Encouraging individuals at high risk to follow proper protective measures. ▪ Educating community about the disease. ▪ Encouraging BCG vaccination of non-vaccinated children. ▪ Encouraging individuals to follow healthy behaviors that protect from TB infection.
Target Groups	<ul style="list-style-type: none"> ▪ General public ▪ Tuberculosis patients and their contacts ▪ Immunocompromised patients ▪ Health care workers ▪ Special categories, as school children and industrial workers
Messages	<ul style="list-style-type: none"> ♦ Information about the disease (symptoms, transmission, complications, preventive measures, treatment) ♦ Importance of children vaccination with BCG ♦ Importance of pasteurization or at least boiling of milk ♦ Importance of medical examination on feeling any symptoms of TB and adherence to treatment until cure ♦ Consulting a physician for the best protective measures for contacts ♦ For health team, information about program procedures and the role of each individual, training on methods of diagnosis, treatment and prevention
Strategies	<ol style="list-style-type: none"> a. Preparation of scientific materials about the disease. b. Sharing in the activities of World Tuberculosis Day (24 March) through coordination and preparation of materials. c. Coordination with other directorates in the Ministry of Health, such as Chest Diseases Directorate, General Directorate of Primary Health Care, General Directorate of Hospital Affairs-Medical supply. d. Coordination with other sectors in the community as National Guard, Military Hospitals, specialized hospitals, Interior Force hospitals, universities, mass media, schools. e. Staff training (medical and paramedical) on diagnosis, case evaluation, follow up of treatment and education of tuberculosis patients and their contacts. f. Coordination with the Global Tuberculosis Control Program and World Health.
Methods	<ul style="list-style-type: none"> ▪ Mass media: Radio & television and newspapers in the form of meetings with specialized personnel, presentation of films, workshops, TV charts ▪ Lectures and workshops in PHCCs, hospitals, schools, mosques, governmental organizations, and social clubs. ▪ School health education. ▪ Printed materials: posters, booklets and brochures. ▪ Films: to identify the disease, its danger and importance of treatment to be presented in the health establishments, schools, etc. ▪ Instructions to TB patients (see Box 16.2)
Note	The quantity and cost of health education materials should be organized with Directorate of Chest Diseases in the Ministry of Health, to be informed with the available budget and targeted locations.

Box 16.2. Instructions to TB patients

Never interrupt treatment even if you are feeling better, as this feeling of improvement means that you are responding to treatment and not a final cure. To be fully cured, you have to take prescribed drugs regularly for at least 6 months under medical supervision.

Interrupting your treatment early makes you susceptible for relapse, which would make your cure very difficult, necessitating years of treatment instead of months.

Swallow your medicine on an empty stomach followed by a large amount of water or soup.

It is necessary to visit hospital or health center regularly, as recommended by the physician.

Consult your physician in case you have to take drugs other than those prescribed for tuberculosis. Refrain from smoking and alcohol, as these destruct your lung and immune system.

Ensure the availability of a sufficient quantity of drugs to prevent interruption. Drugs are provided free of charge by the Ministry of Health.

Vaccinate your child against tuberculosis at birth or as soon as possible.

Invite your contact to visit the nearest health facility.

Keep your house well ventilated, expose your beds to direct sunlight and keep good nutrition.

Keep personal cleanliness.

In case you change your address, inform the health center to apply the required procedures to ensure regular treatment.

17. Patient Centered Approach to TB Care

17.1. Introduction

Patient-centered approach to TB care can be defined as “*providing care that is respectful of and responsive to individual patient preferences, needs and values, and ensuring that patient values guide all clinical decisions*”. The TB patient care and support interventions are recommended to enhance treatment effectiveness. In 1994, WHO launched DOTS (Directly Observed Treatment, Short-course) strategy, which is the internationally recommended strategy for TB control that has been recognized as a highly efficient and cost-effective strategy. The aim of DOTS strategy stated by WHO is to achieve 70% detection rate of sputum smear-positive and 85% cure rate of detected cases. In 2006, DOTS strategy was developed into Stop TB strategy, which was later formulated in to the End-TB strategy. The Patient-Centered Care approach is part of The End-TB strategy, which aims to end the global TB epidemic, reduce TB deaths and new cases by 95% and 90%, respectively and to bring about zero suffering of families facing catastrophic expenses due to TB. As complement, NTP provide treatment of drug resistant TB at district level.

Patient-centered approach to TB care is pillar One in the End-TB strategy that places the TB patient at the heart of medical services delivered. This enables policy makers to consider patients’ benefits and individual’s rights and welfare in planning and strategy design. Further, the patient-centered approach assists the patients to exercise their rights and achieve their responsibilities with transparency, respect and dignity, with consideration to their beliefs and necessities.

During the implementation of patient-centered approach, the NTP considers the social protection schemes to prevent negative impact due to TB disease on TB patients and their families. The NTP uses modern technology for the successful implementation of patient-centered approach through mobile TB teams, which include Health Electronic Surveillance Network (HESN) for TB surveillance and cell phone (SMS and call). Moreover, the mobile teams perform home visit for treatment and follow up of TB patients and their household contact, in support of facility-based treatment.

17.2. The objectives of Patient-centered approach to TB care

The objective of patient-centered approach is to ensure TB patients receive high quality services including diagnosis, treatment and care, without suffering catastrophic cost. Hence understanding needs and conditions for every TB patient, instead of presenting a “one size fits all” system, is part of the patient-centered paradigm. To ensure success of the implementation of patient -centered approach to TB care, NTP opted for home-based DOT, which is carried out by qualified and trained healthcare providers through home visit teams.

17.3. Principles of Patient-centered approach to TB care

- 1 Emphasize on the patient’s needs and priorities.
- 2 State the 5 A’s aspects of care: Assess, Advise, Agree, Assist and Arrange

- 3 Link the TB patient with a suitable trained DOT mobile team provider in patient-centered care.
- 4 Assess the patient's nutrition status and manage undernutrition.
- 5 Identify and address poverty and food needs among TB patients and coordinate with national social protection measures to take care about TB patients.
- 6 Regular follow-up and communication with the TB patient.
- 7 Enhance health education to TB patients by encouraging community participation and leaders as well as the former patients and, health care providers.
- 8 Help the TB patients by linking them to community-based resources and support.
- 9 Coordinate with other health programs such as HIV, diabetes care, maternal and child health, lung health, and mental health services to provide integrated care to help the TB patients.
- 10 Ensure care stability, including palliative and end-of-life care whenever needed.

This strategy was implemented in Saudi Arabia as part of ongoing review of the National TB Control Program to assess its performance and to develop new mechanisms to help achieving the target of tuberculosis control, in line with global strategies. In 2011, the NTP piloted the patient-centered approach to TB care through mobile teams in Riyadh and Gazan districts. After the successful pilot implementation, the strategy was expanded to Jeddah province. This strategy depends on the following actions:

- To ensure home-based treatment administration to TB patients during the intensive phase, and to limit hospitalization only for patients with severe TB in accordance with the attending physician's decision.
- To follow the treatment and preventive measure for patients through the primary health care centers.
- To perform the scheduled laboratory tests, on appropriate time, to monitor both drug-sensitive and resistant TB cases.

17.4. What is DOT?

DOT consists of the process involving a trained healthcare personnel or other designated individual to provide the prescribed TB drugs to the patient and watch him/her swallowing it. Such strategy enables reducing mortality and morbidity and limits the spread of the disease and the development of drug resistance, thereby preserving patient's safety and public health. Hence, this approach contributes in reducing disease-related disability and social and economic burden for patients, families and communities.

By adopting patient-centered approach to TB care through mobile teams (home DOTS strategy) we expect to:

- Reduce burden on hospitals.
- Optimize TB patients follow up and daily compliance to treatment.
- Improve TB surveillance through improvement of quality and regular reporting.
- Enhance treatment adherence, decrease TB default and improve default tracing.

- Improve TB prevention services for contacts by implementing epidemiological investigations.
- Health education to raise awareness among TB patients and contacts, which will enhance adherence.

17.5. Patient-centered care, social support and adherence to drug resistant TB treatment

Since MDR-TB and XDR-TB constitute a serious threat for public health, notably in case of treatment failure, high adherence to drug-resistant TB treatment is crucial in preventing the spread of resistance and in increasing the chances of cure. However, adherence to MDR-TB therapy is a challenge for TB control due to extended length of treatment regimens, burden of pills taking on daily base, medication side effects, financial and social impact on the patients and their families. On the other hand, treatments proposed for such cases are often the last therapeutic option.

Thus, a patient-centered approach, to programmatic management of drug-resistant TB, through DOT mobile team constitutes the best option to ensure adherence to treatment, improve treatment outcomes, and better patient's well-being. It also enables providing social support and decreasing the financial impact on TB patients and their families as well as the community. Further, the home DOT mobile team interventions are designed to respect the TB patient's rights, in line with Standard 9 of the International standards for TB care, reported in WHO guidelines.

17.6. The supervision of Patient-centered approach to TB care at the district level

The patient-centered approach constitutes an essential part of the TB control program at the district level, where it is under the supervision of TB control program coordinators. The Patient-centered approach to TB care DOTS health workers are designated by the infectious disease department at the provincial level. The responsibilities of the DOTS program office include:

- To communicate with the NTP at the directorate of health affairs.
- To take over the administrative and technical role to maintain all needs for Patient-centered approach to TB care program.
- To designate the home DOTS teams and determine their geographical distribution in the district according to PHCC.
- To allocate TB cases to the home DOTS teams according to their geographical and residential location.
- To emphasize completion of information and data of new TB patients.
- To follow up home DOTS teams.
- To coordinate medical supply for provision and maintenance of drugs to home DOTs teams (first line).
- To coordinate medical supply for provision and maintenance of laboratory needs for TB investigation.
- To set up quality control for drug stores and laboratory investigations.
- To follow up results of sputum samples sent to the labs and to communicate these to the home DOTS teams.
- To follow up of the home DOTS teams visits and other activities.
- To regularly supervise and follow up home DOTS teams for samples collection, transportation and sending to regional lab with specific forms; and to entry these forms in HESN system.
- To monitor, evaluate and analyze home DOTS teams' activities.
- To participate in planning follow up of patients' treatment plan and treatment outcome, until completion of treatment regimen.
- To regularly assess home DOTS teams in coordination with the infectious disease department.

- To inform the TB coordinator about the treatment outcomes of patients who complete their treatment; the TB coordinator will register this information in the book record.
- To communicate with TB defaulters and patients who change their home address, and to arrange the treatment plan by coordination with the home DOTS mobile team.
- To address any recommendation suggestion for the promotion and development of patient-centered approach to TB care-home DOT strategy.

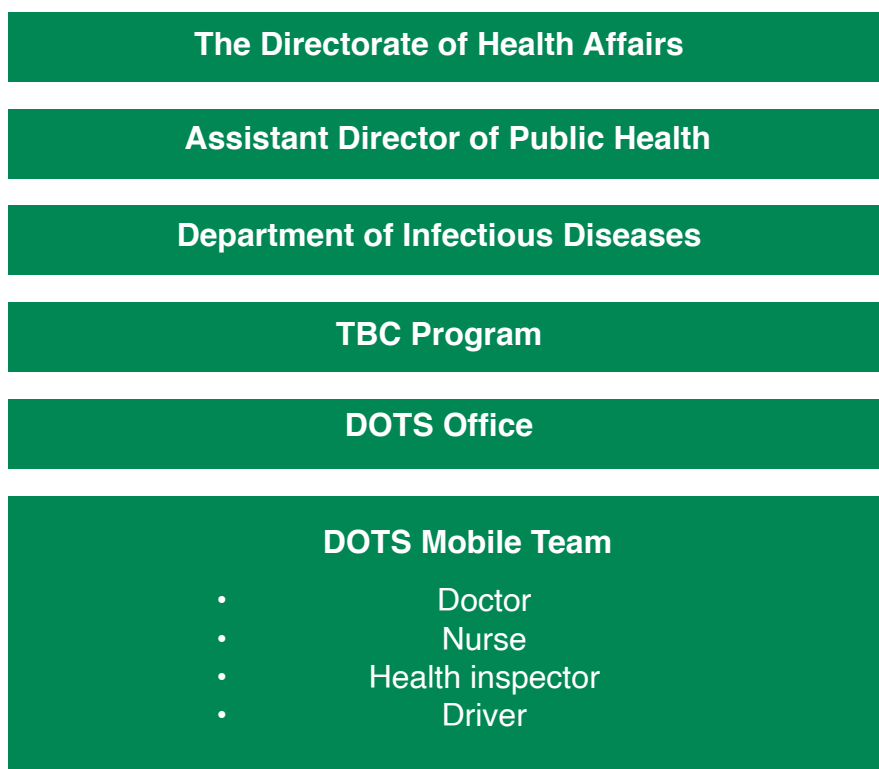

The administrative Chart for Home DOTS Mobile Team

17.7. Home DOTS team responsibilities

- Contact the patient to take the address and determine the date and time of home visit.
- Perform the home visit or, if necessary, to visit the patient at work place or school and fill the treatment card for each visit.
- Regular provision of drugs to TB patients.
- Review the drugs items and doses on regular basis for each patient before the home visit.
- Prepare and fill the TB investigation form, at first visit, and update this form on the following visit, when needed, and enter the data in the HESN system.
- Attend and observe treatment intake by the patient, and document this on the patient card according to treatment plan and the NTP manual.
- Assess and observe the house environment.
- List the TB patient Contacts, fill the Contact forms, perform the TST on first visit and enter Contacts data in HESN system.
- Provide health education to TB patients and their contacts.
- Regular assessment of the patient symptoms and drugs side effects, weigh the patient and refer if needed.
- Fill the treatment follow up forms.
- Collect the sputum samples at the end of the 2nd, 4th, and 6th months from starting anti-TB treatment for new TB cases.

- Collect the sputum samples at the end of the 3rd, 5th, and 8th months for default, relapse and failure.
- Follow up the treatment of extrapulmonary TB cases according to NTP guidelines.
- Monitor retreatment of TB cases should be under strict Patient-centered approach to TB care (home DOTS).
- Follow up of drugs resistant TB cases according to the NTP manual; this includes follow up of patients' treatment, collection of sputum samples, follow up of sputum results, providing health education to patients and their families.
- Collect the sputum samples according to NTP manual (use N95, good ventilation, collect 2 samples).
- Send the samples with forms to the lab on the same day.
- Collect lab results within 72 hours or as soon as possible.
- Communicate the lab results to TB coordinators and treating doctors.
- Tracing for TB treatment default.
- Send regular report about the patient follow up, patient adherence, treatment outcome and the results of sputum investigation.
- Update the TB coordinator on any patient refusing to take TB medication.
- Follow up the new treatment plan in case of change of the previous one.
- Perform any other tasks assigned to the home DOTS team.

17.8. Responsibilities of home DOTS mobile team personnel

17.8.1. The doctor

- 1 Lead the home DOTS mobile team and is responsible for carrying out all the administrative and technical tasks of the team.
- 2 Emphasizes the maintenance and provision of drugs.
- 3 Supervises medication intake for patients under Patient-centered approach to TB care (home DOTS) program and monitors the side effects of the drugs.
- 4 Supervises and collects sputum samples and carries out the appropriate preventive measures.
- 5 Notifies the TB coordinator about the date and time of sputum samples delivery to the regional lab.
- 6 Follows up the results of sputum investigations.
- 7 Supervises the preventive measures for patients contacts according to NTP manual.
- 8 Follows up the performance, reading and interpretation of tuberculin test.
- 9 Sends the results of contact investigation to take appropriate decision regarding repeating tuberculin test, patient referral and treatment of LTBI.
- 10 Follows up the sputum smear and chest x-ray results of suspected TB cases among contacts.
- 11 Refers patients and contacts to hospital.
- 12 Communicates with the patient referral hospital to discuss the treatment plan with treating physician and to update the TB coordinator about referred patient.
- 13 Provides health education to patients and contacts.
- 14 Informs the NTP coordinator about the patients who complete their treatment and the results of sputum smear.
- 15 Informs the TB coordinator about default patients and those changing their address.
- 16 Prepares monthly report about the home DOTS team activities and sends it to the mobile team PHCC manager.
- 17 Sends reports about underperformance of the team members, if any, including neglect and refusal to perform the activities.
- 18 Fills the incentive forms for the team members, in coordination with the PHCC manger, and sends these to the directorate of health affairs.
- 19 Performs any tasks assigned to home DOTS mobile team.

17.8.2. The nurse

- 1 Performs, reads and reports tuberculin test results under the supervision of the doctor in the mobile team.
- 2 Gives TB medication to the patient and registers each intake in the treatment card.
- 3 Collects the sputum samples, fills the laboratory forms and sends these to the lab.
- 4 Follows up the sputum investigation results and informs the doctor in the home DOTS mobile team.
- 5 Weighs the patient at the time of sputum collection.
- 6 Performs any tasks assigned by the head of mobile team.

17.8.3. Health inspector

- 1 Makes a list of TB patient contacts.
- 2 Provides health education to patients and contacts.
- 3 Assess the living environment of the patient and its suitability for home-based treatment.
- 4 Coordinate with mobile team doctor to refer the patient for hospital treatment, when the living environment is not suitable for home-based treatment.
- 5 Coordinates with mobile team doctor to refer the patient contacts to hospital for further investigation, if needed.
- 6 Registers the patient contacts in the patient record book in the health center.
- 7 Follows up sputum smear and chest x-ray results of suspected cases among contacts.
- 8 Performs any tasks assigned by the head of mobile team.

17.8.4. Driver

- 1 Organizes the time of car receiving and driving.
- 2 Ensures delivery of sputum samples to the lab, receipt of results and their transmission to the director of the mobile team.
- 3 Performs any tasks assigns by the head of mobile team.

17.9. Role of home DOTS mobile team in health education for patients and contacts

17.9.1. For all patients

Health education is an essential strategy to fight against TB and prevent its dissemination. It prompts treatment adherence by patients, hence decreases default and drug resistant. The home DOTS mobile teams have a unique role in health education and awareness raising among TB patients and their families about TB disease, mode of transmission, treatment and prevention.

The home DOTS mobile will assess the patient's social condition and educational level, and establish a trust relationship that will enable good interaction and high-level communication. It is highly recommended to involve both patients and their families in communication and dialogue to come up with the most appropriate health education message. This will help achieving high cure rate, decreasing default, disabilities and complications.

The health education messages that should be addressed by home DOTS mobile teams and communicated to the patients are:

- TB is a curable and preventable disease.
- Explain to patient the treatment duration.
- How to use the drugs.
- Compliance is essential for cure and never interrupt treatment even if you are feeling better.
- You may feel with few side effects of drugs and we are here to help you - please do not hesitate to contact us.
- Keep your house well-ventilated, expose your beds to sun light and keep good nutrition.
- Keep personal cleanliness.
- Importance of having a balanced diet.
- In case you change your address, please inform home DOTS mobile team.
- Educate the patients to keep the home DOTS mobile team in case they plan to travel, loose their medication, or develop any complications or symptoms of other disease, in which case an arranged plan would be made to best fit their new condition.
- It is important to avoid taking alcohol and smoking during and after treatment.
- Educate the patient about cough hygiene (spitting into handkerchief or tissue papers or containers, covering the mouth when coughing).

17.9.2. In TB/HIV patients

Home DOTS mobile teams may play a good role in treatment of TB patient with HIV infection as in the following condition:

- TB /HIV patients with untestable viral load.
- If CD4 within the normal range.
- If the living condition is suitable for home treatment with cooperation of the national AIDS program and by consideration of the treating physician advice.

17.9.3. cases among children

The home DOTS mobile team role in the treatment of TB children is similar to that of adults with emphasis on following dimensions:

- Suitability of the living condition for home-based treatment.
- Arrangement of the treatment plan with the pediatric consultant.
- Health education to patient's family members (parents, caregiver, etc.).

17.9.4. Home DOTS mobile teams for TB patients in prisons

It is crucial to have home DOTS mobile team supervise the treatment of TB patients in prison and to arrange this with health services in the Ministry of Interior and the health personnel working in the prison care centers. Home DOTS mobile teams will perform the following activities of TB control program in prisons:

- All the above-mentioned activities specified in the role of home DOTS mobile team, including treatment for new PTB case, retreatment, EPTB, health education, Contacts, sputum investigation, collection of samples, follow up of cases, follow up of sputum investigation results.
- Provision of drugs.
- Cooperation between the home DOTS mobile team and the health center in the prison.
- Training the prison health personnel for the activities of TB control program and the treatment services for TB cases.
- Coordination with the directorate of the prison to provide suitable place for isolation of the TB cases according to criteria and conditions identified by the NTP and infection control directorate in MOH.
- DOTS treatment for TB cases in prison in coordination with treating physicians.

General guidelines

- In case that a patient refuses to collaborate with home DOTS mobile team, to inform the TB coordinator in the district to coordinate with prison officers according to the memos signed by the Ministry of Interior.
- Patients to sign a disclaimer in case they refuse to be visited by home DOTS mobile team and prefer having the treatment at hospital or health center setting.
- Strategies of the NTP Manual to be followed and implemented.
- For the patients other than those treated by home DOTS mobile teams, the TB coordinator to be sure that:
 - ♦ The patients received their treatment according to the NTP guideline
 - ♦ The health personnel in the hospital are trained about NTP activities
 - ♦ Health education is well provided to patients and their families
 - ♦ The patient is compliant to TB treatment
 - ♦ Reporting of cases is adequately done and TB coordinator is updated with treatment process
 - ♦ Regular provision of drugs is ensured
 - ♦ Contact tracing is done
 - ♦ Sputum samples are collected for investigation
 - ♦ Follow up of sputum results is ensured
 - ♦ Coordination with treating physicians is done
- The following patients are to be excluded from treatment at home:
 - ♦ Patients complaining of other diseases
 - ♦ Patients for whom physician decided to hospital-based treatment intake.
 - ♦ Patients with living environment that is unsuitable for home-based treatment.

17.10. Monitoring and follow up of the patient-centered approach to TB care mobile teams' activities

- Supervisory visits by home DOTS office under the TB control program in the district.
- Supervisory visits by the NTP in MOH.
- Weekly reports prepared by home DOTS mobile teams and sent to TB control program in the directorate of health affairs.
- Data and reports prepared by the TB control program in directorate of health affairs and sent to the NTP in MOH.

Practical steps to shift from a centralized facility-based to community-based tuberculosis control services

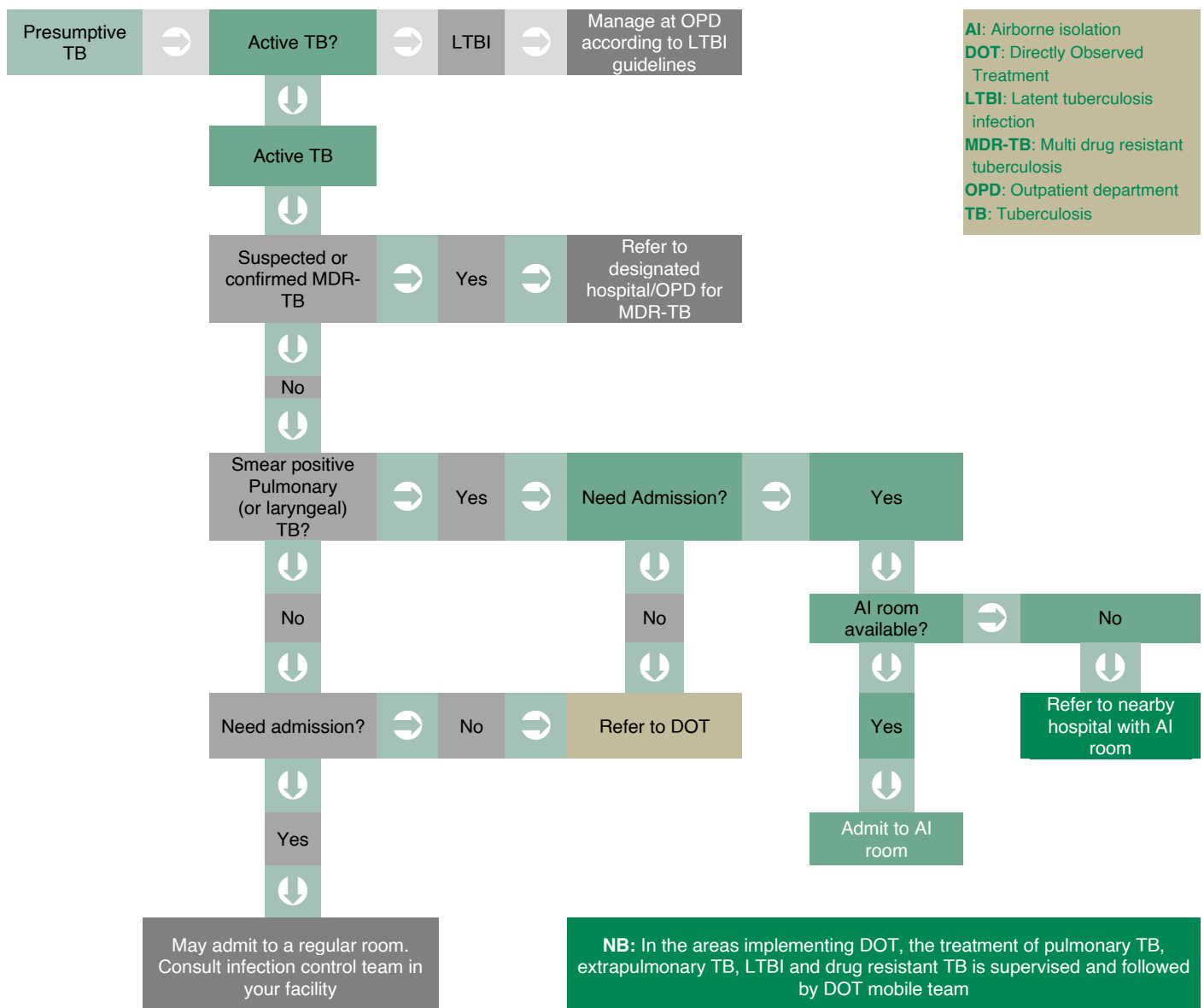

References

World Health Organization. Treatment of Tuberculosis, guidelines for treatment of susceptible tuberculosis and patient care update.2017.

World Health Organization. A Patient-centred approach to TB care. 2018.

World Health Organization. What is DOTS?: A Guide to Understanding the WHO-recommended TB Control Strategy Known as DOTS.1999.

World Health Organization. Companion handbook to the WHO guidelines for the programmatic management of drug-resistant tuberculosis.2014.

WHO/HTM/TB/2014.11.

World Health Organization. The End TB strategy: Global strategy and targets for tuberculosis prevention, care and control after 2015.

WHO/CDS/TB/2018.29

NTP Guideline Appendice/s

Appendix I-International Standard for TB Care

Standards for Diagnosis

- Standard 1:** To ensure early diagnosis, providers must be aware of individual and group risk factors for tuberculosis and perform prompt clinical evaluations and appropriate diagnostic testing for persons with symptoms and findings consistent with tuberculosis.
- Standard 2:** All patients, including children, with unexplained cough lasting two or more weeks or with unexplained findings suggestive of tuberculosis on chest radiographs should be evaluated for tuberculosis.
- Standard 3:** All patients, including children, who are suspected of having pulmonary tuberculosis and are capable of producing sputum should have at least two sputum specimens submitted for smear microscopy or a single sputum specimen for Xpert® MTB/RIF* testing in a quality-assured laboratory. Patients at risk for drug resistance, who have HIV risks, or who are seriously ill, should have Xpert MTB/RIF performed as the initial diagnostic test. Blood-based serologic tests and interferon-gamma release assays should not be used for diagnosis of active tuberculosis.

*As of this writing, Xpert®MTB/RIF (Cepheid Corp. Sunnyvale, California, USA) is the only rapid molecular test approved by WHO for initial use in diagnosing tuberculosis, thus, it is specifically referred to by its trade name throughout this document.

- Standard 4:** For all patients, including children, suspected of having extrapulmonary tuberculosis, appropriate specimens from the suspected sites of involvement should be obtained for microbiological and histological examination. An Xpert MTB/RIF test is recommended as the preferred initial microbiological test for suspected tuberculous meningitis because of the need for a rapid diagnosis.
- Standard 5:** In patients suspected of having pulmonary tuberculosis whose sputum smears are negative, Xpert MTB/RIF and/or sputum cultures should be performed. Among smear- and Xpert MTB/RIF negative persons with clinical evidence strongly suggestive of tuberculosis, antituberculosis treatment should be initiated after collection of specimens for culture examination.
- Standard 6:** For all children suspected of having intrathoracic (i.e., pulmonary, pleural, and mediastinal or hilar lymph node) tuberculosis, bacteriological confirmation should be sought through examination of respiratory secretions (expectorated sputum, induced sputum, gastric lavage) for smear microscopy, an Xpert MTB/RIF test, and/or culture.

Standards for Treatment

- Standard 7:** To fulfill her/his public health responsibility, as well as responsibility to the individual patient, the provider must prescribe an appropriate treatment regimen, monitor adherence to the regimen, and, when necessary, address factors leading to interruption or discontinuation of treatment. Fulfilling these responsibilities will likely require coordination with local public health services and/or other agencies.
- Standard 8:** All patients who have not been treated previously and do not have other risk factors for drug resistance should receive a WHO-approved first-line treatment regimen using quality assured drugs. The initial phase should consist of two months of isoniazid, rifampicin, pyrazinamide, and ethambutol. * The continuation phase should consist of isoniazid and rifampicin given for

4 months. The doses of antituberculosis drugs used should conform to WHO recommendations. Fixed-dose combination drugs may provide a more convenient form of drug administration.

*Ethambutol may be omitted in children who are HIV-negative and who have non-cavitary tuberculosis.

Standard 9: A patient-centered approach to treatment should be developed for all patients in order to promote adherence, improve quality of life, and relieve suffering. This approach should be based on the patient's needs and mutual respect between the patient and the provider.

Standard 10: Response to treatment in patients with pulmonary tuberculosis (including those with tuberculosis diagnosed by a rapid molecular test) should be monitored by follow up sputum smear microscopy at the time of completion of the initial phase of treatment (two months). If the sputum smear is positive at completion of the initial phase, sputum microscopy should be 11 ISTC 3rd edition, 2014 summary performed again at 3 months and, if positive, rapid molecular drug sensitivity testing (line probe assays or Xpert MTB/RIF) or culture with drug susceptibility testing should be performed. In patients with extrapulmonary tuberculosis and in children, the response to treatment is best assessed clinically.

Standard 11: An assessment of the likelihood of drug resistance, based on history of prior treatment, exposure to a possible source case having drug-resistant organisms, and the community prevalence of drug resistance (if known), should be undertaken for all patients. Drug susceptibility testing should be performed at the start of therapy for all patients at a risk of drug resistance. Patients who remain sputum smear-positive at completion of 3 months of treatment, patients in whom treatment has failed, and patients who have been lost to follow up or relapsed following one or more courses of treatment should always be assessed for drug resistance. For patients in whom drug resistance is considered to be likely an Xpert MTB/RIF test should be the initial diagnostic test. If rifampicin resistance is detected, culture and testing for susceptibility to isoniazid, fluoroquinolones, and second-line injectable drugs should be performed promptly. Patient counseling and education, as well as treatment with an empirical second-line regimen, should begin immediately to minimize the potential for transmission. Infection control measures appropriate to the setting should be applied.

Standard 12: Patients with or highly likely to have tuberculosis caused by drug-resistant especially (MDR/XDR) organisms should be treated with specialized regimens containing quality-assured second-line antituberculosis drugs. The doses of antituberculosis drugs should conform to WHO recommendations. The regimen chosen may be standardized or based on presumed or confirmed drug susceptibility patterns. At least five drugs, pyrazinamide and four drugs to which the organisms are known or presumed to be susceptible, including an injectable agent, should be used in a 6–8 month intensive phase, and at least 3 drugs to which the organisms are known or presumed to be susceptible, should be used in the continuation phase. Treatment should be given for at least 18–24 months beyond culture conversion. Patient-centered measures, including observation of treatment, are required to ensure adherence. Consultation with a specialist experienced in treatment of patients with MDR/XDR tuberculosis should be obtained.

Standard 13: An accessible, systematically maintained record of all medications given, bacteriologic response, outcomes, and adverse reactions should be maintained for all patients.

Standards for Addressing HIV Infection and other Co-morbid Conditions

Standard 14: HIV testing and counseling should be conducted for all patients with, or suspected of having, tuberculosis unless there is a confirmed negative test within the previous two months. Because

of the close relationship of tuberculosis and HIV infection, integrated approaches to prevention, diagnosis, and treatment of both tuberculosis and HIV infection are recommended in areas with high HIV prevalence. HIV testing is of special importance as part of routine management of all patients in areas with a high prevalence of HIV infection in the general population, in patients with symptoms and/or signs of HIV-related conditions, and in patients having a history suggestive of high risk of HIV exposure.

Standard 15: In persons with HIV infection and tuberculosis who have profound immunosuppression (CD4 counts less than 50 cells/mm³), ART should be initiated within 2 weeks of beginning treatment for tuberculosis unless tuberculous meningitis is present. For all other patients with HIV and tuberculosis, regardless of CD4 counts, antiretroviral therapy should be initiated within 8 weeks of beginning treatment for tuberculosis. Patients with tuberculosis and HIV infection should also receive cotrimoxazole as prophylaxis for other infections.

Standard 16: Persons with HIV infection who, after careful evaluation, do not have active tuberculosis should be treated for presumed latent tuberculosis infection with isoniazid for at least 6 months.

Standard 17: All providers should conduct a thorough assessment for co-morbid conditions and other factors that could affect tuberculosis treatment response or outcome and identify additional services that would support an optimal outcome for each patient. These services should be incorporated into an individualized plan of care that includes assessment of and referrals for treatment of other illnesses. Particular attention should be paid to diseases or conditions known to affect treatment outcome, for example, diabetes mellitus, drug and alcohol abuse, undernutrition, and tobacco smoking. Referrals to other psychosocial support services or to such services as antenatal or well-baby care should also be provided.

Standards for Public Health

Standard 18: All providers should ensure that persons in close contact with patients who have infectious tuberculosis are evaluated and managed in line with international recommendations. The highest priority contacts for evaluation are:

- Persons with symptoms suggestive of tuberculosis
- Children aged <5 years
- Contacts with known or suspected immunocompromised states, particularly HIV infection
- Contacts of patients with MDR/XDR tuberculosis

Standard 19: Children <5 years of age and persons of any age with HIV infection who are close contacts of an infectious index patient and who, after careful evaluation, do not have active tuberculosis, should be treated for presumed latent tuberculosis infection with isoniazid for at least six months.

Standard 20: Each healthcare facility caring for patients who have, or are suspected of having, infectious tuberculosis should develop and implement an appropriate tuberculosis infection control plan to minimize possible transmission of *M. tuberculosis* to patients and health care workers.

Standard 21: All providers must report both new and re-treatment tuberculosis cases and their treatment outcomes to local public health authorities, in conformance with applicable legal requirements and policies.

Appendix II-Technical TB Program Indicators

Detection indicators

Indicator 1	TB notification rate
Definition	Number of new and relapse cases of TB that are notified per 100,000 population
Numerator	Number of notified new and relapse TB cases during the period of assessment
Denominator	Estimated population during the period of assessment (divided by 100,000)
Disaggregation	By type of T case (bacteriologically confirmed/clinically diagnosed, pulmonary/extrapulmonary), age group, sex, notification source (e.g. non-NTP facilities, prisons, community referral)
Expressed as	Cases per 100,000 population
Data sources	Numerator: Basic management unit TB registers Denominator: UN population division estimates, or national population estimates (especially for sub-national population estimates)
Level	National, sub-national
Frequency	Quarterly, annual
Notes	Cases with unknown TB treatment history should be counted as cases.
Indicator 2	Proportion of registered new and relapse TB patients with documented HIV status
Definition	Number of new and relapse TB patients who had an HIV test result recorded in the TB register expressed as a percentage of the number registered during the reporting period.
Numerator	Number of new and relapse TB patients who had an HIV test result recorded in the TB register during the reporting period.
Denominator	Total number of new and relapse TB patients registered in the TB register during reporting period.
Disaggregation	By age group, sex
Expressed as	%
Data sources	Basic management unit TB registers or quarterly reports on TB case registrations.
Level	National, sub-national
Frequency	Quarterly, annual
Notes	Cases with unknown TB treatment history should be counted as new cases.
Indicator 3	Proportion of registered new and relapse TB patients with documented HIV positive status.
Definition	Number of registered new and relapse TB patients who are found to be HIV-positive, expressed as a percentage of the number registered with documented HIV status during the reporting period.
Numerator	Total number of new and relapse TB patients registered during the reporting period who are documented as HIV-positive during the reporting period.
Denominator	Total number of new and relapse TB patients registered during the reporting period having a documented HIV status, positive or negative during the reporting period.
Disaggregation	By age group, sex
Expressed as	%
Data sources	Basic management unit TB registers or quarterly reports on TB case registrations and quarterly reports on TB treatment outcomes.
Level	National, sub-national
Frequency	Quarterly, annual
Notes	Cases with unknown TB treatment history should be counted as new cases.

Enrolment indicators

Indicator 4	Cotrimoxazole preventive therapy (CPT) among HIV-positive TB patients.
Definition	Proportion of HIV-positive TB patients who received (or are receiving) CPT during their TB treatment among all HIV-positive TB patients registered during the reporting period.
Numerator	Number of HIV-positive TB patients receiving CPT during their TB treatment.
Denominator	Total number of HIV-positive TB patients registered during the reporting period.
Disaggregation	By age group, sex
Expressed as	%
Data sources	Basic management unit TB registers or quarterly reports on TB case registrations and quarterly reports on TB treatment outcomes.
Level	National, sub-national
Frequency	Quarterly, annual
Notes	Cases with unknown TB treatment history should be counted as new cases.
Indicator 5	Proportion of HIV-positive new and relapse TB patients on antiretroviral therapy (ART) during TB treatment.
Definition	Number of HIV-positive new and relapse TB patients who receive ART during TB treatment expressed as a percentage of those registered during the reporting period.
Numerator	Total number of HIV-positive new and relapse TB patients started on TB treatment during the reporting period, who are already on ART or started on ART during TB treatment.
Denominator	Total number of HIV-positive new and relapse TB patients registered during the reporting period.
Disaggregation	By age group, sex
Expressed as	%
Data sources	Basic management unit TB registers or quarterly reports on TB case registrations and quarterly reports on TB treatment outcomes; Pre-ART registers and ART registers.
Level	National, sub-national
Frequency	Quarterly, annual
Notes	Cases with unknown TB treatment history should be counted as new cases.

Final Outcome indicators

Indicator 6	TB treatment success rate
Definition	Proportion of TB cases successfully treated (cured plus treatment completed) among all TB cases notified to the National Health Authorities during a specified period.
Numerator	Number of TB cases registered in a specified period that subsequently were successfully treated, excluding patients found to have drug-resistant TB and placed on second-line treatment.
Denominator	Total number of TB cases registered in the same period, excluding patients found to have drug-resistant TB and placed on second-line treatment.
Disaggregation	Primarily by bacteriological confirmation status, previous treatment history (new and relapse, previously treated excluding relapse) and HIV status. Also by age group and sex.
Expressed as	%
Data sources	Quarterly TB treatment outcome reports
Level	National, sub-national
Frequency	Quarterly, annual
Notes	Cases with unknown TB treatment history should be counted as new cases.

Indicators for Drug-Resistant TB Detection

Indicator 7	TB patients with result for isoniazid and rifampicin drug susceptibility testing (DST).
Definition	Number of TB cases (in each risk category) with DST result for both isoniazid and rifampicin during the period of assessment.
Numerator	Number of TB cases identified (in each risk category) during the period of assessment.
Denominator	By previous treatment history (new, retreatment) and each other risk category specified in the national policy.
Disaggregation	Absolute numbers, proportion
Expressed as	Numerator: Laboratory registers Denominator: Basic management unit TB registers and treatment cards. For some risk categories (e.g. contacts of MDR-TB) the information may have to be traced from elsewhere in the medical records.
Data sources	National, regional, district and WHO
Level	6 months
Frequency	To be computed separately for patients tested for rifampicin-resistant TB (RR-TB) alone in sites using Xpert MTB/RIF.
Notes	TB patients with result for isoniazid and rifampicin drug susceptibility testing (DST).
Indicator 8	Confirmed MDR-TB cases detected among TB patients tested for susceptibility to isoniazid and rifampicin.
Definition	Number of confirmed MDR-TB cases (in each risk category) during the period of assessment.
Numerator	Number of TB cases (in each risk category) with DST result for both isoniazid and rifampicin during the period of assessment.
Denominator	By new, retreatment and each other risk category specified in the national policy.
Disaggregation	Absolute numbers, proportion (%)
Expressed as	Numerator: Laboratory registers Denominator: Identical to the numerator of Detection Indicator 1
Data sources	National, regional, district and WHO
Level	6 months
Frequency	To be computed separately for patients tested for rifampicin-resistant TB (RR-TB) alone in sites using Xpert MTB/RIF. For annual reporting to WHO (absolute numbers): RR-/MDR-TB cases stratified by new, retreatment and previous history unknown.
Notes	Confirmed MDR-TB cases detected among TB patients tested for susceptibility to isoniazid and rifampicin.
Indicator 9	Confirmed MDR-TB cases tested for susceptibility to any fluoroquinolone and any second-line injectable.
Definition	Number of confirmed MDR-TB cases tested for susceptibility to a fluoroquinolone and any second-line injectable anti-TB medication during the period of assessment.
Numerator	Number of confirmed MDR-TB cases during the period of assessment.
Denominator	None
Disaggregation	Absolute numbers, proportion (%)
Expressed as	Numerator: Laboratory registers Denominator: Identical to the (non-disaggregated) numerator of Detection Indicator 2
Data sources	National, regional, district and WHO
Level	6 months
Frequency	Patients detected with rifampicin-resistant TB (RR-TB) in sites using Xpert MTB/RIF to be included in the denominator as well as numerator.
Notes	Confirmed MDR-TB cases tested for susceptibility to any fluoroquinolone and any second-line injectable.

Indicator 10	Confirmed XDR-Tb cases detected among MDR-TB patients tested for susceptibility to any fluoroquinolone and any second-line injectable.
Definition	Number of confirmed XDR-TB cases during the period of assessment.
Numerator	Number of confirmed MDR-TB cases tested for susceptibility to a fluoroquinolone and a second-line injectable anti-TB medication during the period of assessment.
Denominator	None
Disaggregation	Absolute numbers, proportion (%)
Expressed as	Numerator: Laboratory registers Denominator: Identical to the numerator of Detection Indicator 3
Data sources	National, regional, district and WHO
Level	6 months
Frequency	To be computed only for patients with confirmed MDR-TB, given that the XDR-TB definition requires resistance to isoniazid as well.
Notes	Confirmed XDR-Tb cases detected among MDR-TB patients tested for susceptibility to any fluoroquinolone and any second-line injectable.
Indicator 11	Interval between presumption of RR-/MDR-TB and DST results
Calculation	The duration in days between the date when the TB patient was identified as being in a risk category as per the national policy and the date of the DST results for isoniazid and rifampicin. The calculation is done on all cases with DST or Xpert MTB/RIF results (sensitive or resistant) entered in the Laboratory register during the period of assessment. The number of episodes included in the calculation should also be included.
Disaggregation	None
Expressed as	Number of episodes included in the calculation; mean interval and range(min-max) in days.
Data sources	Second-line TB treatment registers; laboratory register
Level	National, regional and district
Frequency	6 months
Notes	In sites using Xpert MTB/RIF the date of the first results showing rifampicin resistance is used, regardless of whether the same patient was confirmed to be MDR-TB or not subsequently.

Enrolment indicators

Indicator 12	RR-/MDR-TB cases (presumptive or confirmed) enrolled on MDR-TB treatment.
Definition	Number of RR-/MDR-TB cases (presumptive or confirmed) registered and started on a prescribed MDR-TB treatment regimen during the period of assessment.
Comparator	Number of RR-/MDR-TB cases (presumptive or confirmed) eligible for treatment with second-line drugs during the period of assessment.
Disaggregation	By age group (<15y / 15y+), sex
Expressed as	Absolute numbers, ratio of newly enrolled to eligible
Data sources	Number of cases started on treatment: Second-line TB treatment registers, Number of eligible cases: Basic management unit TB registers and laboratory registers
Level	National, regional, district and WHO
Frequency	6 months
Notes	Patients detected with rifampicin-resistant TB (RR-TB) in sites using Xpert MTB/RIF to be included in the denominator as well as numerator.
Indicator 13	Confirmed RR-/MDR-TB cases enrolled on MDR-TB treatment regimen.
Definition	Number of confirmed RR-/MDR-TB cases registered and started on a prescribed MDR-TB treatment regimen during the period of assessment.
Comparator	Number of confirmed RR-/MDR-TB cases detected during the period of assessment.
Disaggregation	By HIV-status and ART status (cases with HIV on ART/cases with HIV but not known to be on ART).
Expressed as	Absolute numbers, ratio of newly enrolled to detected cases
Data sources	Number of confirmed RR-/MDR-TB cases started on treatment: Second-line TB treatment registers Number of confirmed RR-/MDR-TB cases: Laboratory registers, identical to the (non-disaggregated) numerator of Detection Indicator 2 inclusive of any other RR-TB cases.
Level	National, regional, district and WHO
Frequency	6 months
Notes	Patients detected with rifampicin-resistant TB (RR-TB) in sites using Xpert MTB/RIF to be included in the denominator as well as numerator.

Indicator 14	Confirmed XDR-TB cases enrolled on XDR-TB treatment regimen.
Definition	Number of confirmed XDR-TB cases registered and started on a prescribed XDR-TB treatment regimen during the period of assessment.
Comparator	Number of confirmed XDR-TB cases detected during the period of assessment.
Disaggregation	None
Expressed as	Absolute numbers, ratio of newly enrolled to detected cases
Data sources	Number of confirmed XDR-TB cases started on treatment: Second-line TB treatment registers Number of confirmed XDR-TB cases: Laboratory registers, identical to the (non-disaggregated) numerator of Detection Indicator 4.
Level	National, regional, district and WHO
Frequency	6 months
Notes	To be completed only for patients with confirmed XDR-TB as per definition (i.e. including resistance to isoniazid).
Indicator 15	Interval between RR-/MDR-TB diagnosis and start of MDR-TB treatment.
Definition	The duration in days between the date of RR-/MDR-TB confirmation and the date when the patient started a prescribed second-line drug regimen. The calculation is done on all confirmed RR-/MDR-TB cases recorded on the second-line TB treatment register during the period of assessment. If treatment was started before the confirmatory DST was reported, then the interval is marked as zero days. The number of episodes included in the calculation should also be indicated.
Disaggregation	None
Expressed as	Number of episodes included in the calculation; mean interval and range (min-max) in days
Data sources	Second-line TB treatment registers
Level	National, regional, district
Frequency	6 months
Notes	In sites using Xpert MTB/RIF the date of the first result showing rifampicin resistance is used, regardless of whether the same patient was confirmed to be MDR-TB or not subsequently.

Interim results indicators

Indicator 16	RR-/MDR-TB cases on MDR-TB treatment regimen with negative culture by six months.
Numerator	Number of confirmed pulmonary RR-/MDR-TB cases registered and started on a prescribed MDR-TB treatment with negative results for culture in month 6 of their treatment.
Denominator	Number of confirmed RR-/MDR-TB cases registered and started on treatment for MDR-TB during the period of assessment.
Disaggregation	None
Expressed as	Absolute numbers, proportion (%)
Data sources	Second-line TB treatment registers
Level	National, regional, district
Frequency	3 months
Notes	Patients with rifampicin-resistant TB (RR-TB) in sites using Xpert MTB/RIF who are on treatment to be included in the denominator as well as numerator. Applies only to pulmonary cases; all cases included in denominator.
Indicator 17	RR-/MDR-TB cases on MDR-TB treatment regimen who died by six months.
Numerator	Number of confirmed RR-/MDR-TB cases registered and started on a prescribed MDR-TB treatment who died of any cause by the end of month 6 of their treatment.
Denominator	Number of confirmed RR-/MDR-TB cases registered and started on treatment for MDR-TB during the period of assessment.
Disaggregation	None
Expressed as	Absolute numbers, proportion (%)
Data sources	Second-line TB treatment registers
Level	National, regional, district
Frequency	3 months
Notes	Patients with rifampicin-resistant TB (RR-TB) in sites using Xpert MTB/RIF who are on treatment to be included in the denominator as well as numerator.

Indicator 18	RR-/MDR-TB cases on MDR-TB treatment regimen who were lost to follow-up by six months.
Numerator	Number of confirmed RR-/MDR-TB cases registered and started on a prescribed MDR-TB treatment who were lost to follow-up by the end of month 6 of their treatment.
Denominator	Number of confirmed RR-/MDR-TB cases registered and started on treatment for MDR-TB during the period of assessment.
Disaggregation	None
Expressed as	Absolute numbers, proportion (%)
Data sources	Second-line TB treatment registers
Level	National, regional, district
Frequency	3 months
Notes	Patients with rifampicin-resistant TB (RR-TB) in sites using Xpert MTB/RIF who are on treatment to be included in the denominator as well as numerator.
Indicator 19	Patients on MDR-TB treatment regimen found not to have RR-/MDR-TB.
Definition	Number of patients started on a prescribed MDR-TB treatment regimen during the period of assessment and later found not to have RR-/MDR-TB.
Disaggregation	None
Expressed as	Absolute numbers
Data sources	Second-line TB treatment registers
Level	National, regional, district
Frequency	3 months
Indicator 20	Patients on XDR-TB treatment regimen found not to have XDR-TB.
Definition	Number of patients started on a prescribed XDR-TB treatment regimen during the period of assessment and later found not to have XDR-TB.
Disaggregation	None
Expressed as	Absolute numbers
Data sources	Second-line TB treatment registers
Level	National, regional, district
Frequency	3 months

Final outcome indicators

Indicator 21	<ol style="list-style-type: none"> 1 RR-/MDR-TB patients on an MDR-TB treatment regimen with an outcome of "Cured" 2 RR-/MDR-TB patients on an MDR-TB treatment regimen with an outcome of "Treatment completed" 3 RR-/MDR-TB patients on an MDR-TB treatment regimen with an outcome of "Treatment failed" 4 RR-/MDR-TB patients on an MDR-TB treatment regimen with an outcome of "Died" 5 RR-/MDR-TB patients on an MDR-TB treatment regimen with an outcome of "Lost for follow-up" 6 RR-/MDR-TB patients on an MDR-TB treatment regimen with an outcome of "Not evaluated"
Numerator	<p>Number of confirmed RR-/MDR-TB cases registered for MDR-TB treatment during the period of assessment assigned one of the following outcomes respectively:</p> <ol style="list-style-type: none"> 1 Cured 2 Treatment completed 3 Treatment failed 4 Died 5 Lost to follow-up 6 Not evaluated
Denominator	Number of confirmed RR-/MDR-TB cases registered for treatment and starting a prescribed MDR-TB treatment regimen during the period of assessment.
Disaggregation	XDR-TB/non-XDR-TB; HIV positive cases
Expressed as	Absolute number, proportion (%)
Data sources	Second-line TB treatment registers
Level	National, regional, district and WHO
Frequency	Annual (calendar year)



Appendix III-Forms and Registers used by National Tuberculosis Program



Kingdom of Saudi Arabia
Ministry of Health
Public Health Agency
NTCPP



البرنامج الوطني لمكافحة الدرن
National Tuberculosis Control & Prevention Program

Region/ District

Form :5

Tuberculosis Treatment Referral/Transfer

(Complete top part in triplicate)

Tick for this referral or transfer: Referral¹ or Transfer² Date of referral/ transfer.....

Name/address of referring/transferring facility.

From (sending facility):..... Sending BMU:.....

To (receiving facility):..... Receiving BMU

Name of patient..... Age..... Sex: M F

Address of patient (if moving, future address):

Diagnosis:.....

(For Transfer) BMU TB Register No..... Date TB treatment started:

*CAT I, II Other (CPT, ART etc):

Drugs patient is receiving

Remarks (e.g. side-effects observed):.....

Name / signature of person sending the patient

Documented evidence of HIV tests (and results) during or before TB treatment should be reported.

For use by facility receiving referred / transferred patient

BMU..... Facility

BMU TB Register No..... Name of patient

The above patient reported at this facility on..... (date)

Name / signature of person receiving the patient, Date

Return this part to facility sending referred / transferred patient as soon as patient has reported.

● **Referral** is the process of moving a TB patient **prior to registration in a BMU TB Register** for the purpose of start of treatment (treatment closer to patient's home). The BMU receiving a "referred" patient is responsible to inform the facility sending the patient about the care provided.

● **Transfer** is the process of moving between 2 BMU a **TB patient registered in a BMU TB Register** to continue his treatment in another area with a different BMU TB Register. The BMU 'transferring-out' a patient is responsible to report the treatment outcome, after getting the information from the BMU completing the treatment. The BMU receiving a patient 'transferred-in' is responsible for informing the BMU sending the patient 1) of the arrival of the patient and 2) at the end of the treatment, of the treatment outcome.

Note: A facility referring or transferring large numbers of patients such as large hospitals may use separate forms for referral and transfer and may have a specific register for referrals.



Region/District

Second-line TB treatment card

Form:6

Second-line Registration Number
 Date of second-line treatment registration
 Treatment Centre
 Patient Name
 Nationalities
 Address & Telephone
 District
 Sex (circle one) M F
 Age: DOB
 Initial weight (kg)
 Height (cm)
 Site (circle one or both) Pulmonary Extrapulmonary
 If extrapulmonary, specify site

Registration Group	Choose one only
New	<input type="checkbox"/>
Relapse	<input type="checkbox"/>
After loss to follow-up	<input type="checkbox"/>
After failure of first treatment with first-line drugs	<input type="checkbox"/>
After failure of retreatment regimen with first-line drugs	<input type="checkbox"/>
Other (previously treated without known outcome)	<input type="checkbox"/>
Transfer in (from another second-line treatment programme) if yes name of center:	Yes <input type="checkbox"/> No <input type="checkbox"/>

Previous Tuberculosis Treatment Episodes			
District TB Register No. (i.e. BMU register number)	Start Date (if unknown put year)	Regimen (write regimen in drug abbreviations)	Outcome

HIV INFORMATION			
HIV Testing done (circle one): Y N Unknown			
Date of Test:	Result:		
Started on ART (circle one): Y / N	Date:		
Started on CPT (circle one): Y / N	Date:		

Past medical history			
Hypertension <input type="checkbox"/>	Diabetes <input type="checkbox"/>	Thyroid diseases <input type="checkbox"/>	Renal disease <input type="checkbox"/>
Liver diseases <input type="checkbox"/>	Smoking <input type="checkbox"/>	Other	
Previous use of second-line drugs for more than one month? Yes / No / Unknown If Yes, indicate in Table above			

Meetings of review panel
 (medical commission, selection committee, consilium)

Meetings of the review panel: dates and decisions		
Date	Decision	Next Date

Drug Abbreviations			
First-line drugs	second-line drugs		
H=isoniazid	Am=amikacin	Pto=Prothionamide	Bdq=bedaquiline
R=rifampicin	Km=Kanamycin	Cs=cycloserine	Clr=clarithromycin
R=ethambutol	cm=capreomycin	"Pas=p-amino - salicylic acid"	Cfz=clofazimine
S=streptomycin	lfx=levofloxacin		Dim=delamanid
Z=Pyrazinamide	Mfx=Moxifloxacin		lpm=imipenem
	Ofx=ofloxacin	Amx/cVx=amoxicillin/ clavulanate	Lzd=linezolid
	Gfx=gatifloxacin		Mpm=meropenem

Transfer In (from another second-line treatment programme) if yes name of centre:



Month of Treatment	Sputum Microscopy		
	Date*	Sample Number	Results
Prior**			
0			
1			
2			
3			
4			
5			
6			
7			
8			
9			
10			
11			
12			
13			
14			
15			
16			
17			
18			
19			
20			
21			
22			
23			
24			

Month of Treatment	Culture		
	Date*	Sample Number	Results
Prior**			
0			
1			
2			
3			
4			
5			
6			
7			
8			
9			
10			
11			
12			
13			
14			
15			
16			
17			
18			
19			
20			
21			
22			
23			
24			

Drug Sensitivity Test Results			
	برنامج الوطني لمكافحة الدرن National Tuberculosis Control & Prevention Program		
	Date of Sample Collection	Date of DST Results	Results
H			
R			
E			
S			
Am			
Km			
Cm			
FQ			
Other			
Other			
Xpert MTB/RIF			

Notation method for DST:
 R=resistant
 S=susceptible
 C=contaminated
 Unk=Unknown

§ Indicate near result if initial resistance was detected on line-probe assay or Xpert MTB/RIF

Notes:
 *All dates in both tables are the dates the sputum was collected from the patient
 **The date the sputum was collected that led to the patient being registered with MDT-TB (if performed)